



85V/120A N-Channel Advanced Power MOSFET

Features

- N-channel, normal level
- Very low on-resistance RDS(on)

BVDSS	85	V
ID	120	A
RDSON@VGS=10V	4.1	mΩ

Applications

- Industrial power supplies
- Boost converters
- Rectifier
- Telecom

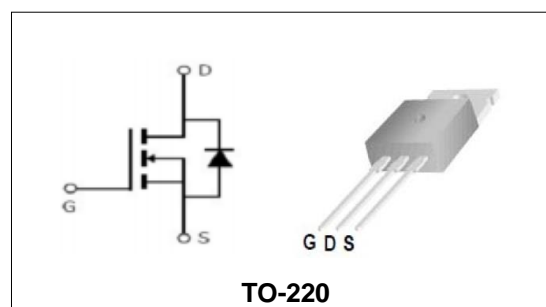

Order Information

Product	Package	Marking	Tube	Carton
PTP12HG08	TO-220	PTP12HG08	50PCS	5000PCS

Absolute Maximum Ratings

Symbol	Parameter	Rating	Unit
Common Ratings (TC=25°C Unless Otherwise Noted)			
$V_{(BR)DSS}$	Drain-Source Breakdown Voltage	85	V
V_{GS}	Gate-Source Voltage	±20	V
T_J	Maximum Junction Temperature	150	°C
T_{STG}	Storage Temperature Range	-55 to 150	°C
I_S	Diode Continuous Forward Current	TC =25°C 120	A
Mounted on Large Heat Sink			
E_{AS}	Single Pulse Avalanche Energy (Note1)	506	mJ
I_{DM}	Pulse Drain Current Tested (Silicon Limit) (Note2)	TC =25°C 480	A
I_D	Continuous Drain current	TC =25°C 120	A
P_D	Maximum Power Dissipation	TC =25°C 176	W
$R_{θJC}$	Thermal Resistance Junction-to-Case (Note3)	0.71	°C/W

**85V/120A N-Channel Advanced Power MOSFET**

Symbol	Parameter	Condition	Min.	Typ.	Max.	Unit
Static Electrical Characteristics @ T_J = 25°C (unless otherwise stated)						
V _{(BR)DSS}	Drain- Source Breakdown Voltage	VGS=0V ID=250μA	85	--	--	V
I _{DSS}	Zero Gate Voltage Drain current	VDS=80V,VGS=0V	--	--	1	μA
I _{GSS}	Gate-Body Leakage Current	VGS=±20V,VDS=0V	--	--	±100	nA
V _{GS(TH)}	Gate Threshold Voltage	VDS=VGS,ID=250μA	2	--	4	V
R _{DS(ON)}	Drain-Source On-State Resistance (Note4)	VGS=10V, ID=50A	--	4.1	5.2	mΩ
Dynamic Electrical Characteristics @ T_J = 25°C (unless otherwise stated) (Note5)						
C _{iss}	Input Capacitance	VDS=40V, VGS=0V, F=1MHz	--	4310	--	pF
C _{oss}	Output Capacitance		--	694	--	pF
C _{rss}	Reverse Transfer Capacitance		--	27.5	--	pF
Q _g	Total Gate Charge	VDS=40V, ID=50A, VGS=10V	--	70.8	--	nC
Q _{gs}	Gate-Source Charge		--	12	--	nC
Q _{gd}	Gate-Drain Charge		--	35	--	nC
Switching Characteristics (Note5)						
t _{d(on)}	Turn-on Delay Time	VDD=40V, ID=30A, RG=10Ω VGS=10V	--	57	--	nS
t _r	Turn-on Rise Time		--	78	--	nS
t _{d(off)}	Turn-off Delay Time		--	70	--	nS
t _f	Turn-off Fall Time		--	41	--	nS
Source- Drain Diode Characteristics @ T_J = 25°C (unless otherwise stated)						
V _{SD}	Forward on voltage	IS=50A,VGS=0V	--	--	1.2	V
t _{rr}	Reverse Recovery Time	VDS=40V,IF=30A, dI/dt=100A/us	--	48	--	nS
Q _{rr}	Reverse Recovery Charge		--	67	--	nC

Note:

- Limited by T_{Jmax}, starting T_J = 25° C, RG =25Ω, VDS =42.5V, VGS =10V. Part not recommended for use above this value.
- Repetitive Rating: Pulse width limited by maximum junction temperature.
- Surface Mounted on FR4 Board, t ≤ 10 sec.
- Pulse Test: pulse width ≤ 300 us, duty cycle ≤ 2%.
- Guranteed by design, not subject to production testing.



85V/120A N-Channel Advanced Power MOSFET

Typical Characteristics

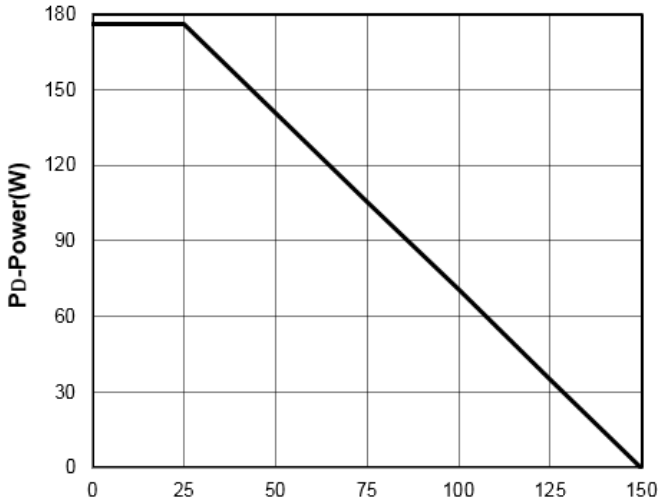

Figure1: T_j Junction Temperature (°C)

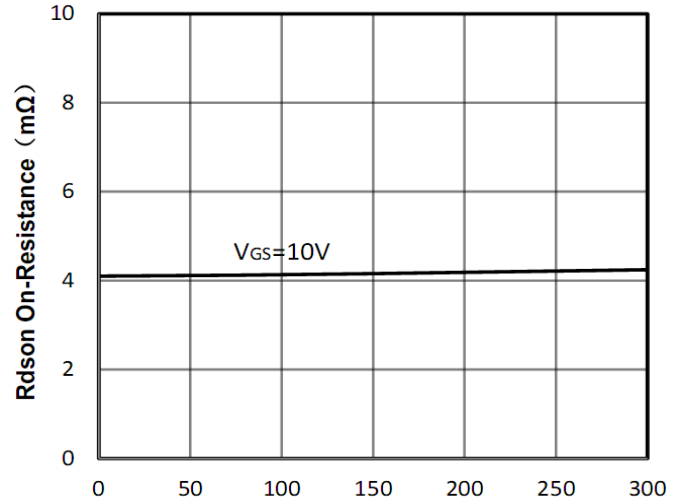

Figure2: I_d Drain Current (A)

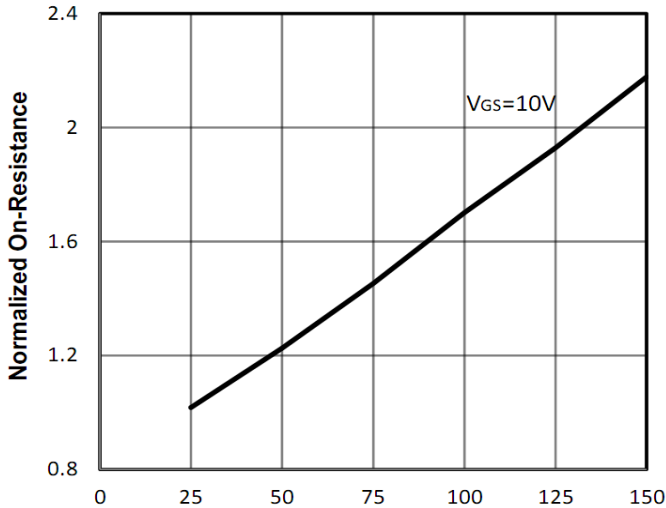

Figure3: T_j Junction Temperature (°C)

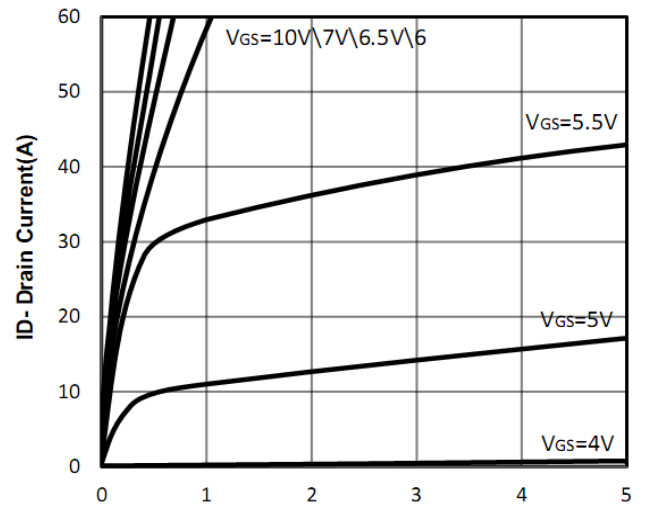

Figure4: V_{ds} Drain-Source Voltage (V)

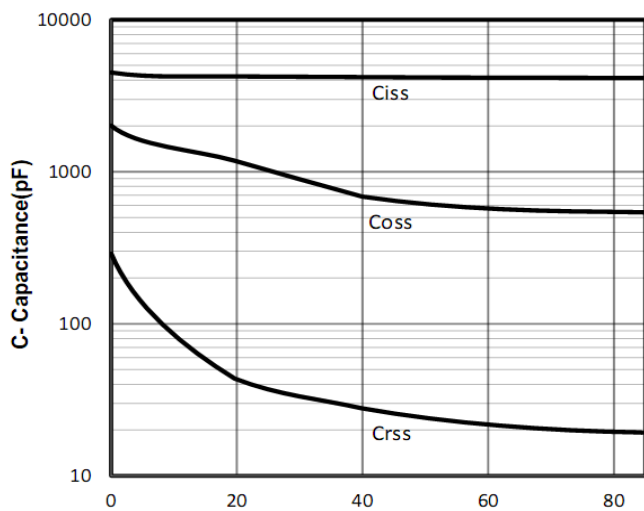

Figure5: V_{ds} Drain-Source Voltage (V)

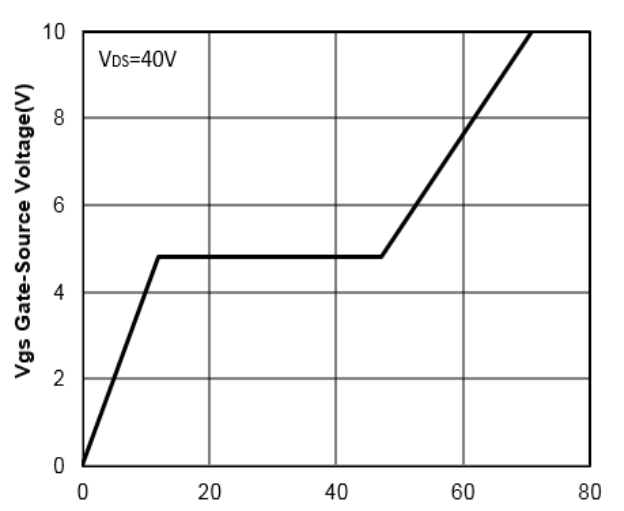

Figure6: Q_g Gate Charge (nC)



85V/120A N-Channel Advanced Power MOSFET

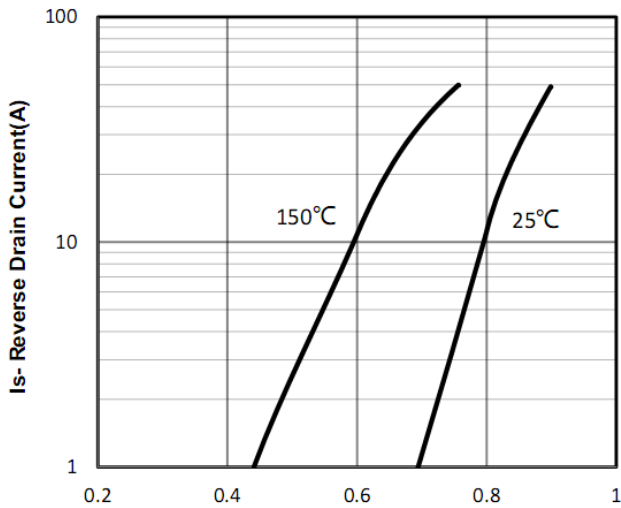

Figure7: Vsd Source-Drain Voltage (V)

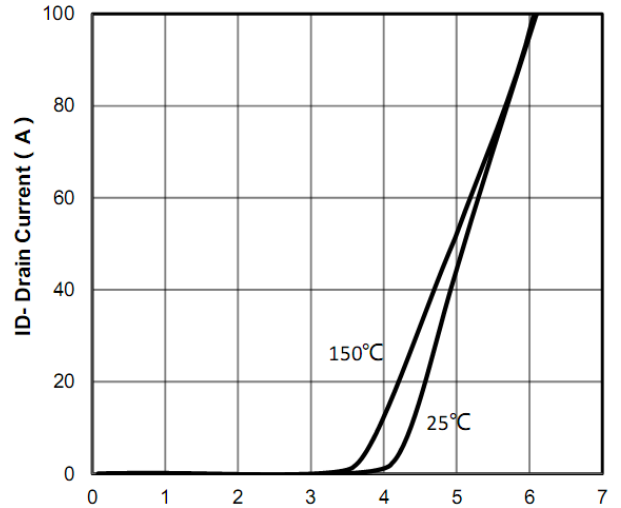

Figure8: Vgs Gate-Source Voltage (V)

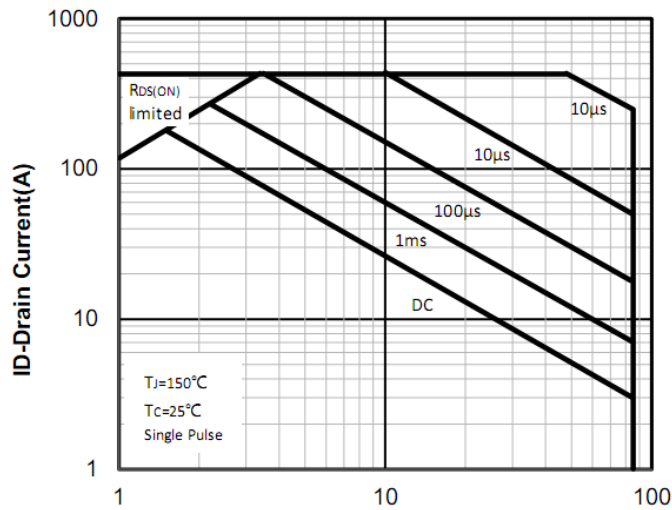

Figure9: VDS Drain -Source Voltage (V)

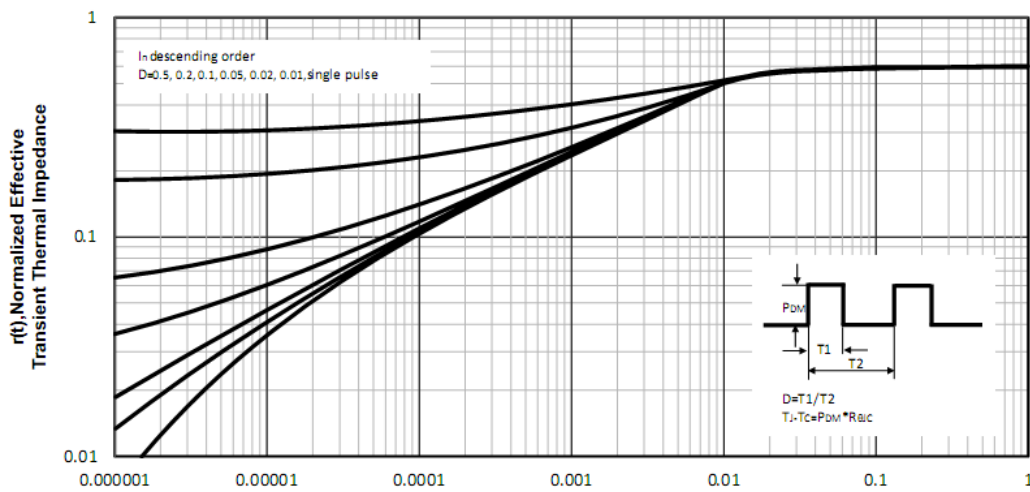

Figure10: Square Wave Pulse Duration (sec)

85V/120A N-Channel Advanced Power MOSFET

Test Circuit and Waveform:

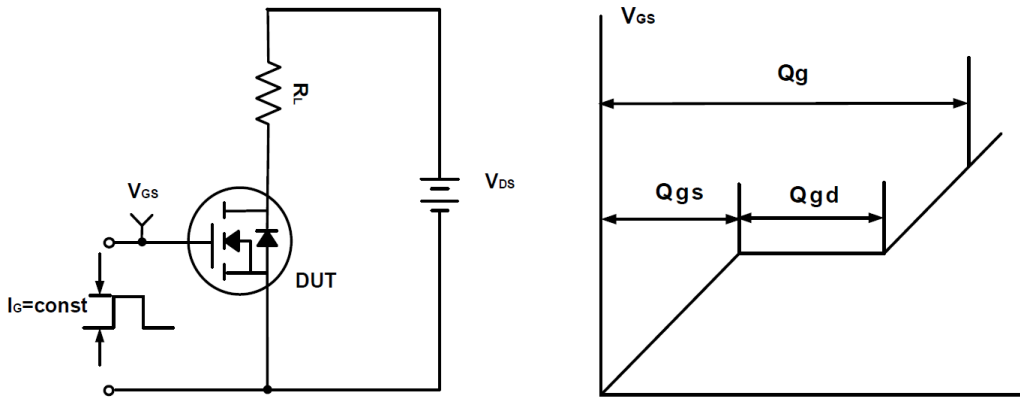

Figure A Gate Charge Test Circuit & Waveforms

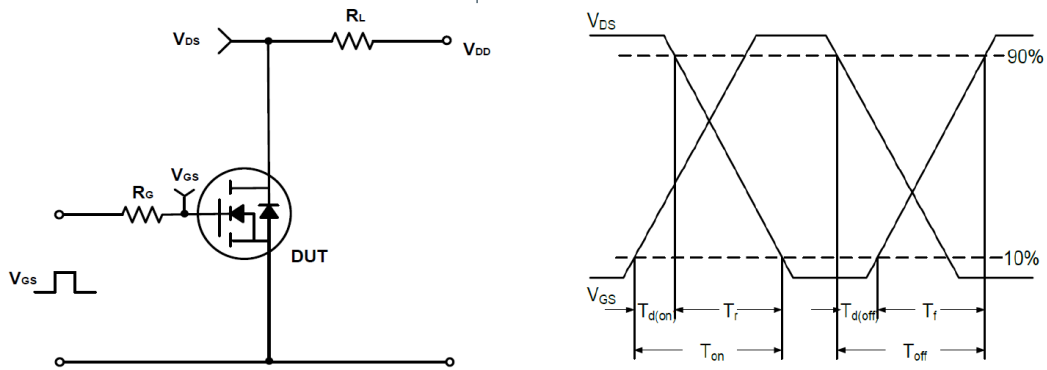

Figure B Switching Test Circuit & Waveforms

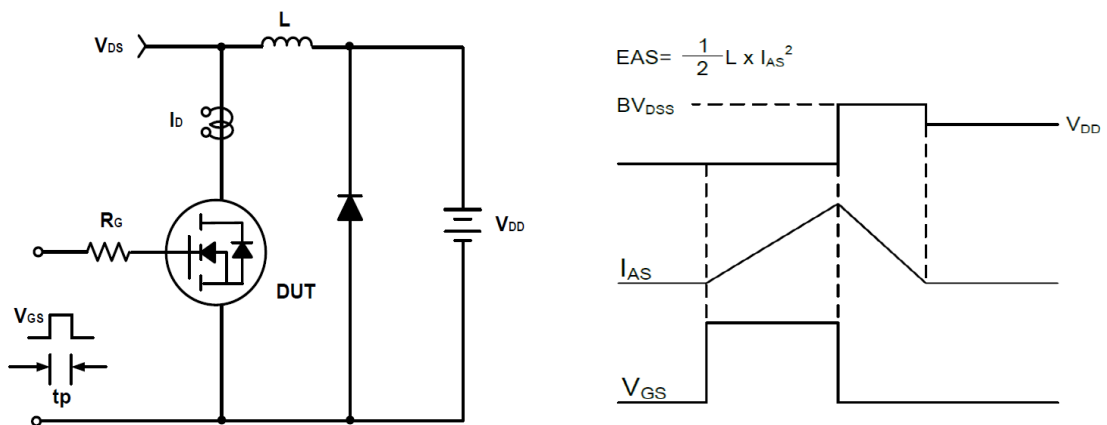
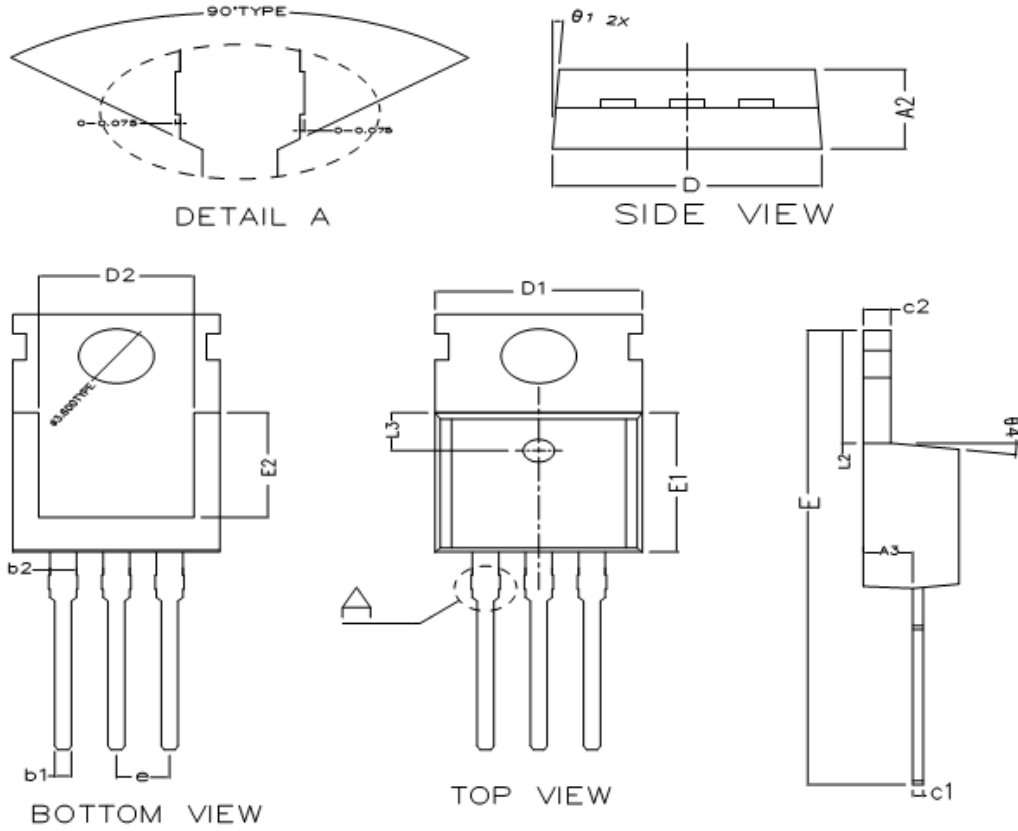

Figure C Unclamped Inductive Switching Circuit & Waveforms



85V/120A N-Channel Advanced Power MOSFET

TO-220 Package Outline Dimensions (Units: mm)



COMMON DIMENSIONS (UNITS OF MEASURE IS mm)			
	MIN	NORMAL	MAX
A2	4.470	4.570	4.670
A3	2.300	2.350	2.400
b1	0.750	0.800	0.850
b2	1.27 TYPE		
c1	0.450	0.500	0.550
c2	1.250	1.300	1.380
D	9.900	10.000	10.100
D1	10.000TYPE		
D2	8.000TYPE		
E	28.660	28.860	29.060
E1	9.000	9.100	9.200
E2	7.000TYPE		
e	2.540TYPE		
L2	6.350	6.500	6.650
L3	2.50TYPE		
θ_1	3° TYPE		
θ_2	3° TYPE		
θ_3	7° TYPE		
θ_4	7° TYPE		