



## 85V/100A N-Channel MOSFET

### Features

- N-channel, normal level
- Very low on-resistance RDS(on)

BVDSS	85	V
ID	100	A
RDSON@VGS=10V	4.3	mΩ

### Applications

- Industrial power supplies
- Boost converters
- Rectifier
- Telecom
- Battery management system

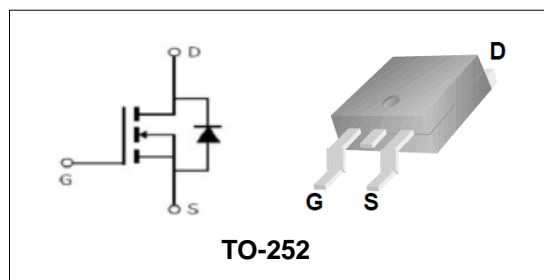

TO-252

### Order Information

Product	Package	Marking	Reel Size	Reel	Carton
PGD08N055	TO-252	PGD08N055	13inch	2500PCS	50000PCS

### Absolute Maximum Ratings

Symbol	Parameter	Rating	Unit	
<b>Common Ratings (TC=25°C Unless Otherwise Noted)</b>				
$V_{(BR)DSS}$	Drain-Source Breakdown Voltage	85	V	
$V_{GS}$	Gate-Source Voltage	±20	V	
$T_J$	Maximum Junction Temperature	150	°C	
$T_{STG}$	Storage Temperature Range	-55 to 150	°C	
$I_S$	Diode Continuous Forward Current	TC =25°C	100	A
<b>Mounted on Large Heat Sink</b>				
$E_{AS}$	Single Pulse Avalanche Energy (Note1)	342	mJ	
$I_{DM}$	Pulse Drain Current Tested (Silicon Limit) (Note2)	TC =25°C	400	A
$I_D$	Continuous Drain current	TC =25°C	100	A
$P_D$	Maximum Power Dissipation	TC =25°C	105	W
$R_{θjc}$	Thermal Resistance Junction-to-Case (Note3)	0.71	°C/W	

**85V/100A N-Channel MOSFET**

Symbol	Parameter	Condition	Min.	Typ.	Max.	Unit
<b>Static Electrical Characteristics @ T<sub>J</sub> = 25°C (unless otherwise stated)</b>						
V <sub>(BR)DSS</sub>	Drain- Source Breakdown Voltage	VGS=0V ID=250μA	85	--	--	V
I <sub>DSS</sub>	Zero Gate Voltage Drain current	VDS=80V,VGS=0V	--	--	1	μA
I <sub>GSS</sub>	Gate-Body Leakage Current	VGS=±20V,VDS=0V	--	--	±100	nA
V <sub>GS(TH)</sub>	Gate Threshold Voltage	VDS=VGS,ID=250μA	2	3	4	V
R <sub>DS(ON)</sub>	Drain-Source On-State Resistance (Note4)	VGS=10V, ID=50A	--	4.3	5.5	mΩ
<b>Dynamic Electrical Characteristics @ T<sub>J</sub> = 25°C (unless otherwise stated) (Note5)</b>						
C <sub>iss</sub>	Input Capacitance	VDS=40V,	--	2924	--	pF
C <sub>oss</sub>	Output Capacitance	VGS=0V,	--	771	--	pF
C <sub>rss</sub>	Reverse Transfer Capacitance	F=1MHz	--	15	--	pF
Q <sub>g</sub>	Total Gate Charge	VDS=40V,	--	48	--	nC
Q <sub>gs</sub>	Gate-Source Charge	ID=50A,	--	13	--	nC
Q <sub>gd</sub>	Gate-Drain Charge	VGS=10V	--	19	--	nC
<b>Switching Characteristics (Note5)</b>						
t <sub>d(on)</sub>	Turn-on Delay Time	VDD=40V,	--	19	--	nS
t <sub>r</sub>	Turn-on Rise Time	ID=50A,	--	33	--	nS
t <sub>d(off)</sub>	Turn-off Delay Time	VGS=10V	--	29	--	nS
t <sub>f</sub>	Turn-off Fall Time	RG=4.7Ω	--	19	--	nS
<b>Source- Drain Diode Characteristics @ T<sub>J</sub> = 25°C (unless otherwise stated)</b>						
V <sub>SD</sub>	Forward on voltage	IS=50A,VGS=0V	--	--	1.2	V
t <sub>rr</sub>	Reverse Recovery Time	IS=50A,VGS=0V,	--	52	--	nS
Q <sub>rr</sub>	Reverse Recovery Charge	dI/dt=100A/us	--	73	--	nC

Note:

- Limited by TJmax, starting TJ = 25° C, RG =25Ω, VDS =20V, VGS =10V. Part not recommended for use above this value.
- Repetitive Rating: Pulse width limited by maximum junction temperature.
- Surface Mounted on FR4 Board, t ≤ 10 sec.
- Pulse Test: pulse width ≤ 300 us, duty cycle ≤ 2%.
- Guaranteed by design, not subject to production testing.



85V/100A N-Channel MOSFET

Typical Characteristics

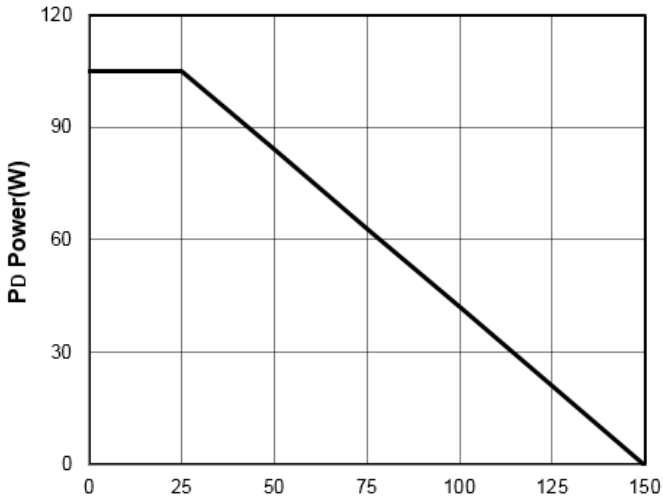

Figure1: T<sub>J</sub> Junction Temperature (°C)

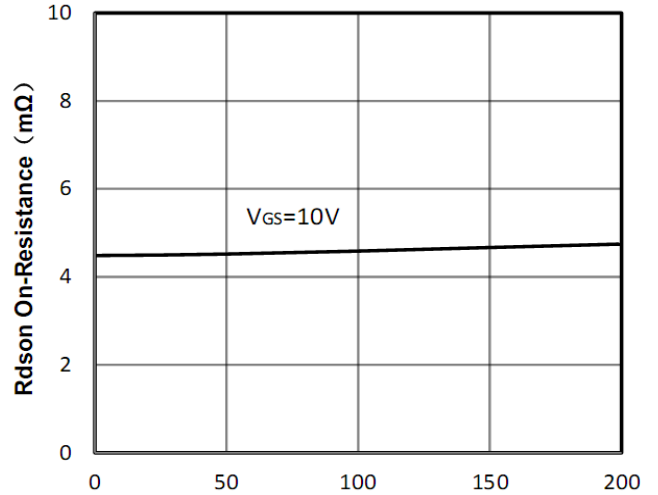

Figure2: I<sub>D</sub> Drain Current (A)

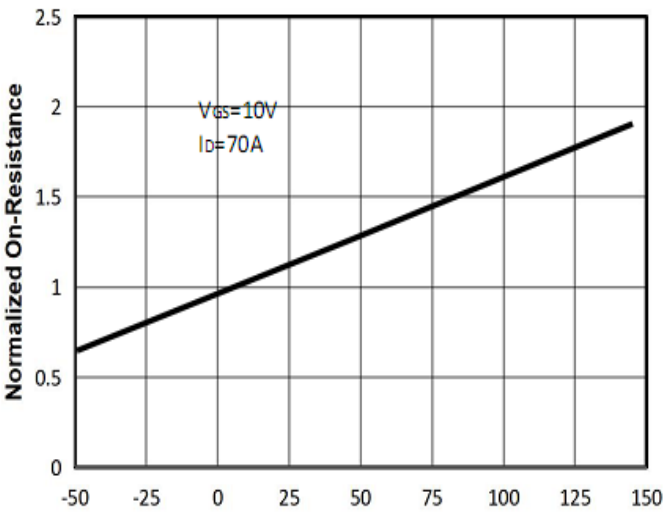

Figure3: T<sub>J</sub> Junction Temperature (°C)

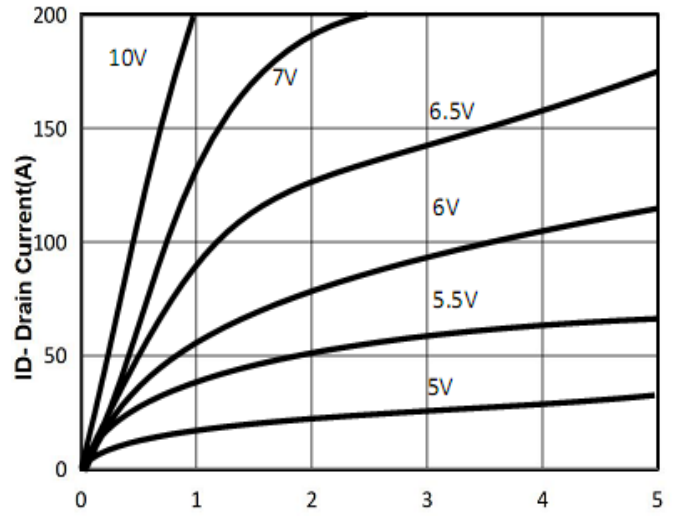

Figure4: V<sub>DS</sub> Drain-Source Voltage (V)

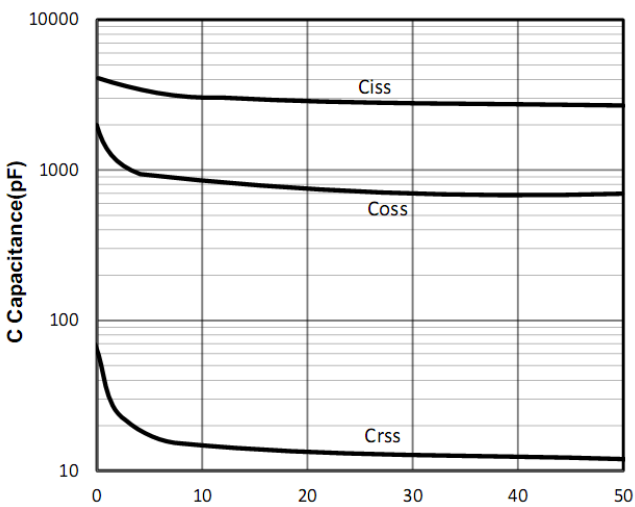

Figure5: V<sub>DS</sub> Draun-Source Voltage (V)

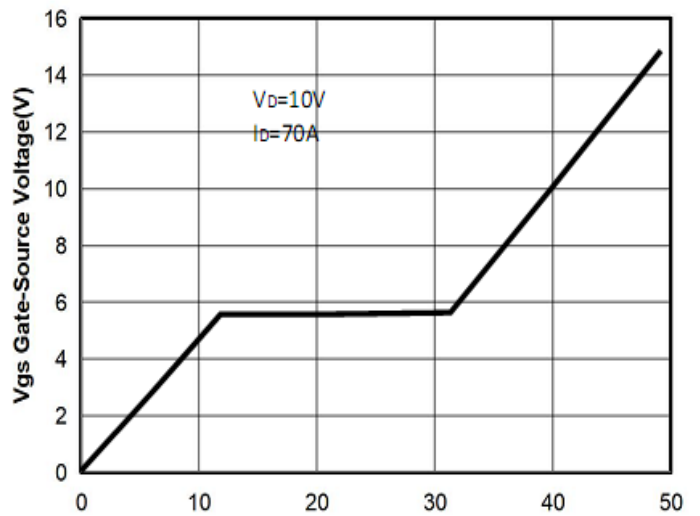

Figure6: Q<sub>g</sub> Gate Charge (nC)



85V/100A N-Channel MOSFET

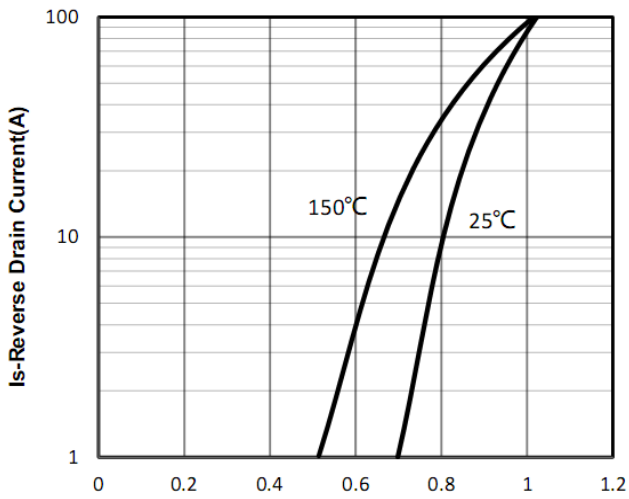

Figure7: Vsd Source-Drain Voltage (V)

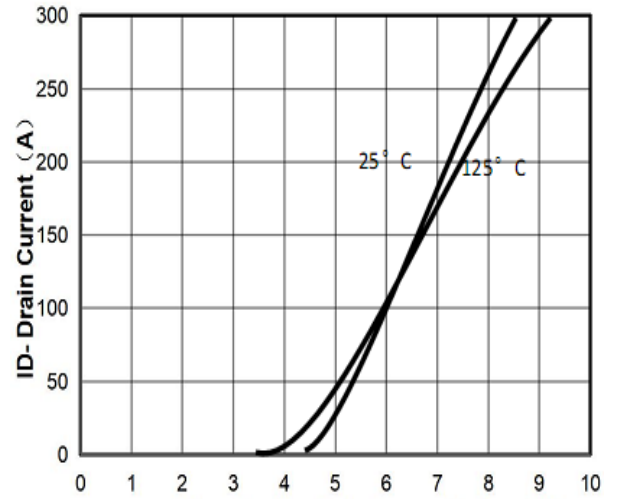

Figure8: Vgs Gate-Source Voltage (V)

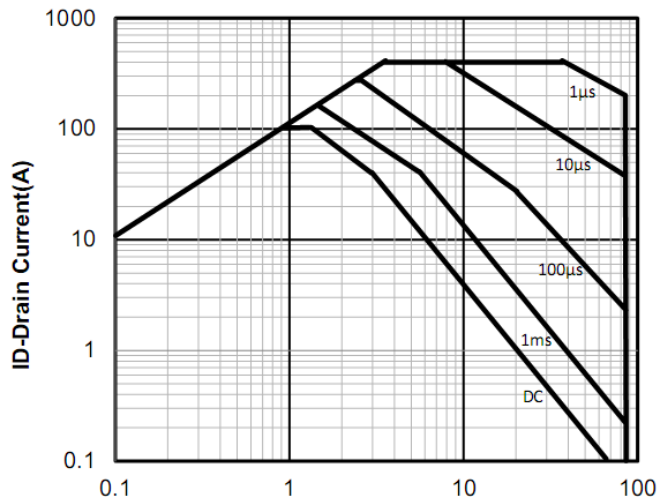

Figure9: Vds Drain-Source Voltage (V)

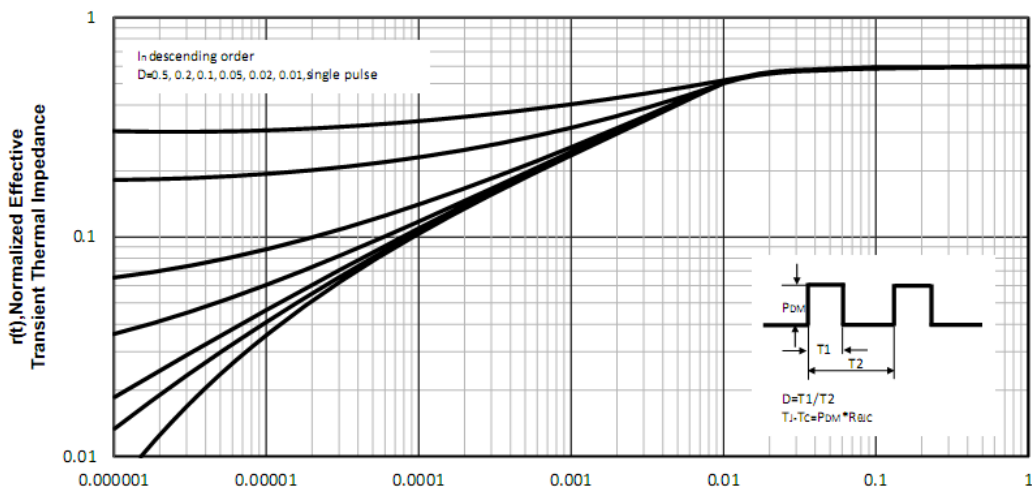

Figure10: Square Wave Pulse Duration (sec)

## 85V/100A N-Channel MOSFET

### Test Circuit and Waveform:

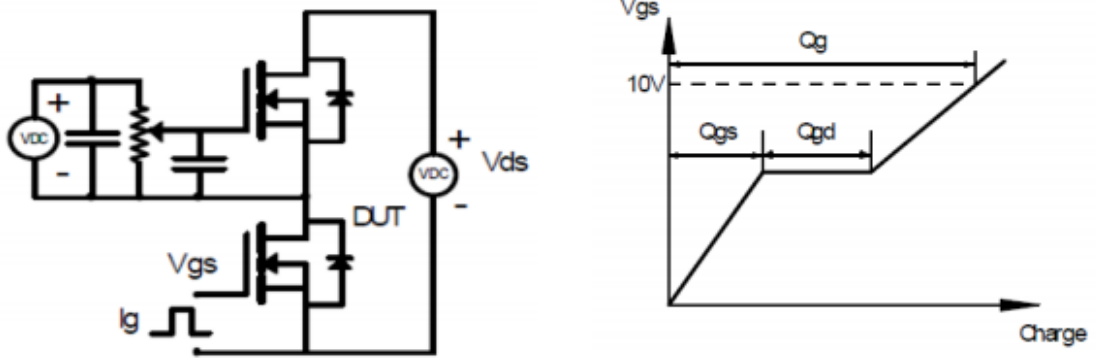

Figure A Gate Charge Test Circuit & Waveforms

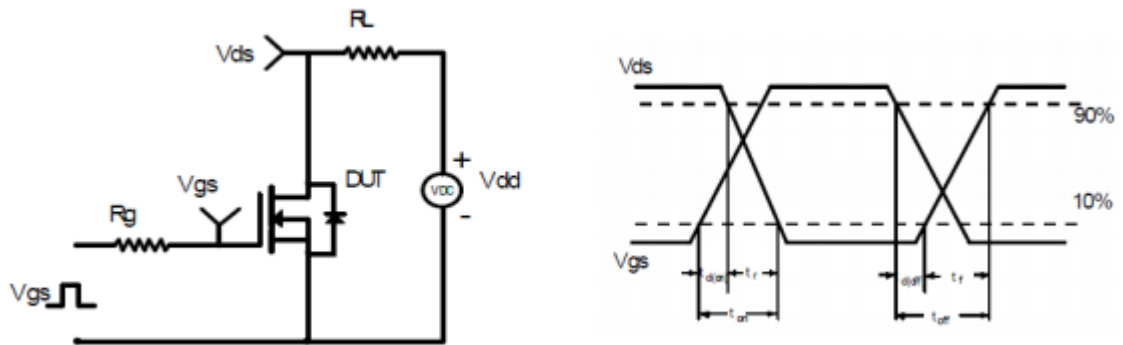

Figure B Switching Test Circuit & Waveforms

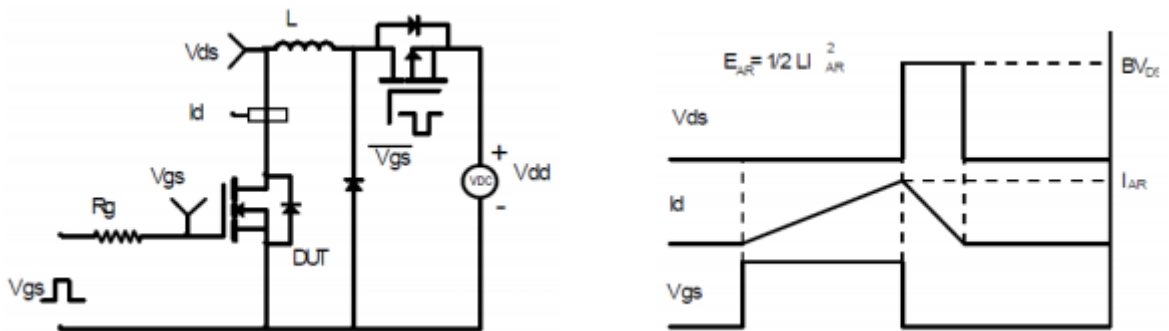
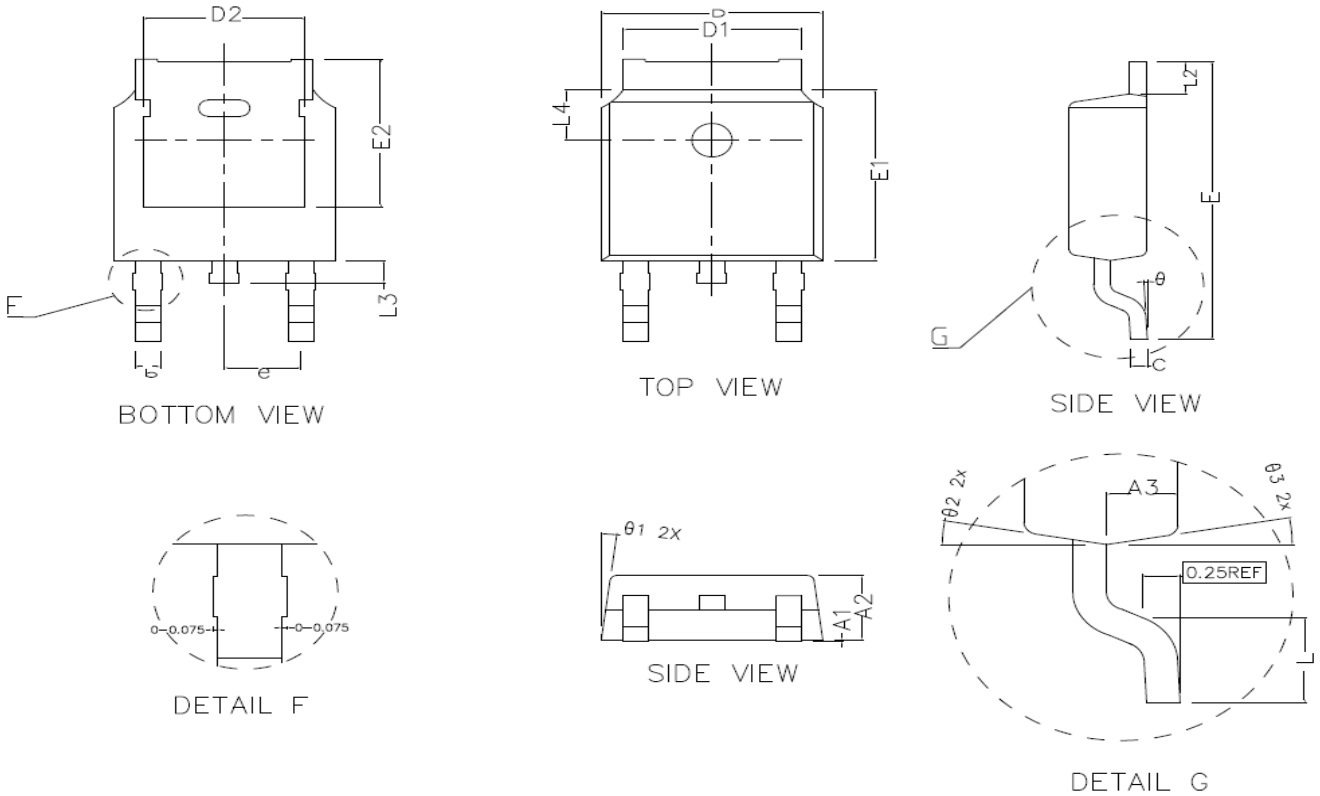

Figure C Unclamped Inductive Switching Circuit & Waveforms



TO-252 Package Outline Dimensions (Units: mm)



COMMON DIMENSIONS (UNITS OF MEASURE IS mm)			
	MIN	NORMAL	MAX
A1	0.000	0.100	0.150
A2	2.200	2.300	2.400
A3	1.020	1.070	1.120
b	0.710	0.760	0.810
c	0.460	0.508	0.550
D	6.500	6.600	6.700
D1	5.330REF		
D2	4.830REF		
E	9.900	10.100	10.300
E1	6.000	6.100	6.200
E2	5.600REF		
e	2.286TYPE		
L	1.400	1.550	1.700
L2	1.10REF		
L3	0.80REF		
L4	1.80REF		
θ	0~8°		
θ1	7° TYPE		
θ2	10° TYPE		
θ3	10° TYPE		