



-30V/-7A P-Channel Enhancement Mode Power MOSFET

Features

- Trench Power LV MOSFET technology
- High density cell design for Low RDS(ON)
- High Speed switching

BVDSS	-30	V
ID	-7	A
RDSON@VGS=-4.5V	18	mΩ
RDSON@VGS=-2.5V	22	mΩ

Applications

- Battery protection
- Load switch
- Power management

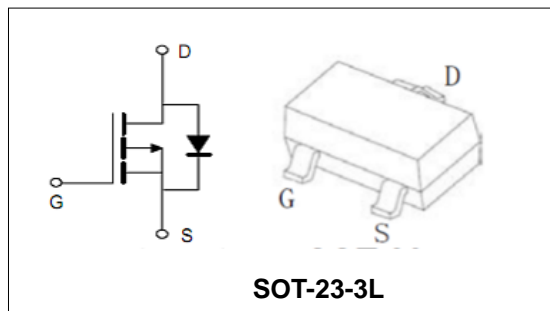

Order Information

Product	Package	Marking	Reel Size	Reel	Carton
PTL3107	SOT-23-3L	3117	7inch	3000PCS	180000PCS

Absolute Maximum Ratings

Symbol	Parameter	Rating	Unit
Common Ratings (TC=25°C Unless Otherwise Noted)			
$V_{(BR)DSS}$	Drain-Source Breakdown Voltage	-30	V
V_{GS}	Gate-Source Voltage	±20	V
T_J	Maximum Junction Temperature	150	°C
T_{STG}	Storage Temperature Range	-55 to 150	°C
I_S	Diode Continuous Forward Current	$T_A = 25^\circ\text{C}$ -7	A
Mounted on Large Heat Sink			
I_{DM}	Pulse Drain Current Tested (Silicon Limit) (Note1)	$T_A = 25^\circ\text{C}$ -28	A
I_D	Continuous Drain current	$T_A = 25^\circ\text{C}$ -7	A
P_D	Maximum Power Dissipation	$T_A = 25^\circ\text{C}$ 1.9	W
$R_{\theta JA}$	Thermal Resistance Junction-to-Ambient (Note2)	65.7	°C/W

**-30V/-7A P-Channel Enhancement Mode Power MOSFET**

Symbol	Parameter	Condition	Min.	Typ.	Max.	Unit
Static Electrical Characteristics @ T_J = 25°C (unless otherwise stated)						
V _{(BR)DSS}	Drain- Source Breakdown Voltage	VGS=0V ID=-250μA	-30	--	--	V
I _{DSS}	Zero Gate Voltage Drain current	VDS=-30V,VGS=0V	--	--	-1	μA
I _{GSS}	Gate-Body Leakage Current	VGS=±20V,VDS=0V	--	--	±100	nA
V _{GS(TH)}	Gate Threshold Voltage	VDS=VGS,ID=-250μA	-1	-1.5	-2.5	V
R _{DS(ON)}	Drain-Source On-State Resistance (Note3)	VGS=-10V, ID=-7A	--	18	25	mΩ
		VGS=-4.5V, ID=-5A	--	22	36	mΩ
Dynamic Electrical Characteristics @ T_J = 25°C (unless otherwise stated) (Note4)						
C _{iss}	Input Capacitance	VDS= -15V, VGS=0V, F=1MHz	--	1500	--	pF
C _{oss}	Output Capacitance		--	327	--	pF
C _{rss}	Reverse Transfer Capacitance		--	276	--	pF
Q _g	Total Gate Charge	VDS= -15V, ID= -7A, VGS= -10V	--	130	--	nC
Q _{gs}	Gate-Source Charge		--	5.3	--	nC
Q _{gd}	Gate-Drain Charge		--	7.6	--	nC
Switching Characteristics (Note4)						
t _{d(on)}	Turn-on Delay Time	VDD=-15V, ID=-4.2A, RG=2.5Ω, VGS=-10V	--	14	--	nS
t _r	Turn-on Rise Time		--	20	--	nS
t _{d(off)}	Turn-off Delay Time		--	95	--	nS
t _f	Turn-off Fall Time		--	65	--	nS
Source- Drain Diode Characteristics @ T_J = 25°C (unless otherwise stated)						
V _{SD}	Forward on voltage (Note3)	IS=-3.5A,VGS=0V	--	--	-1.2	V

Note:

1. Repetitive Rating: Pulse width limited by maximum junction temperature.
2. Surface Mounted on FR4 Board, t ≤ 10 sec
3. Pulse Test: pulse width ≤ 300 us, duty cycle ≤ 2%.
4. Guaranteed by design, not subject to production testing.



-30V/-7A P-Channel Enhancement Mode Power MOSFET

Typical Characteristics

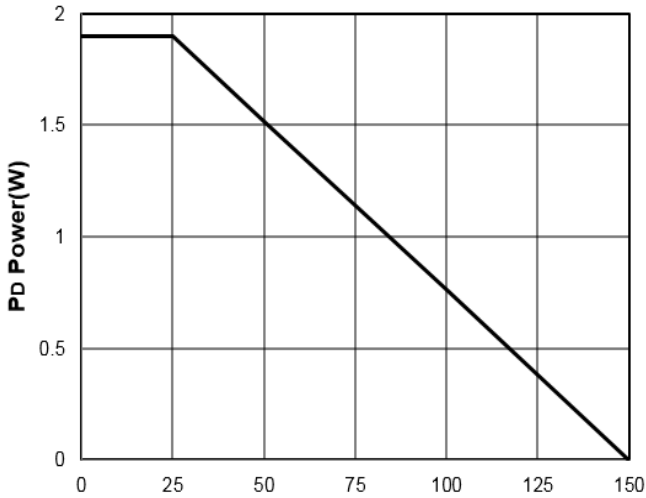

Figure1: Tj Junction Temperature (°C)

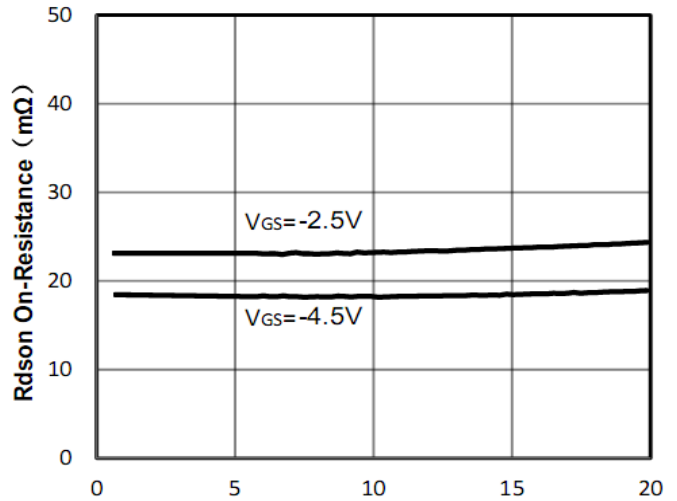

Figure2: -Id Drain Current (A)

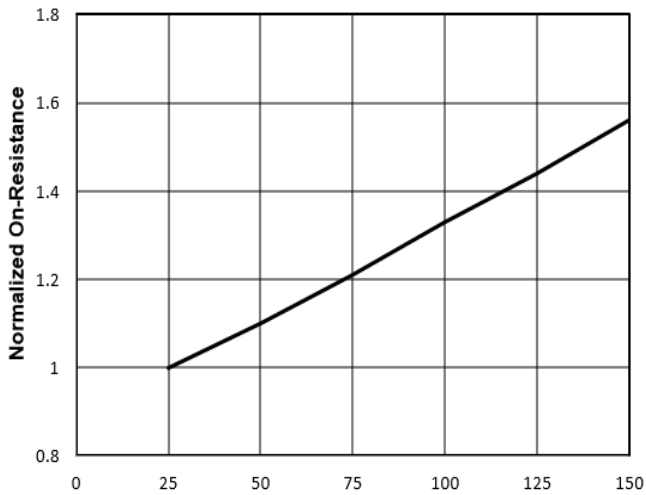

Figure3: Tj Junction Temperature (°C)

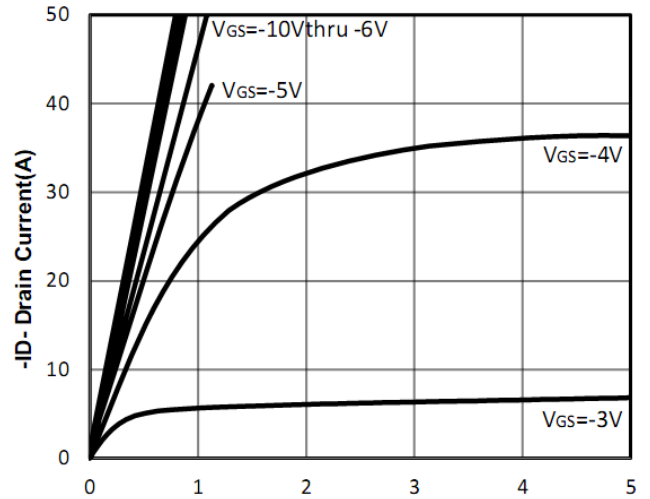

Figure4: -Vds Drain-Source Voltage (V)

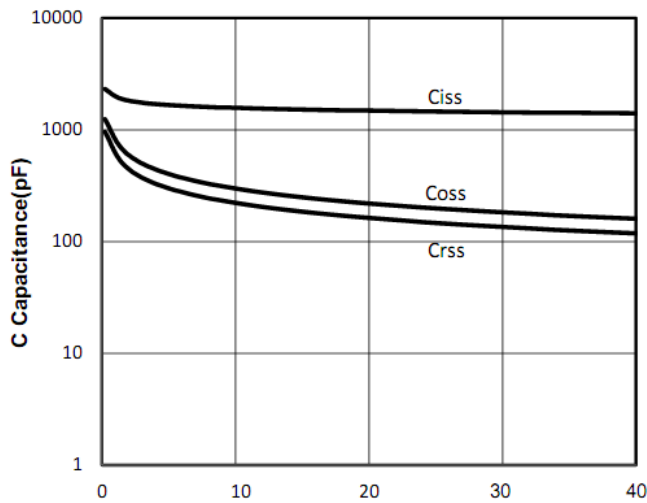

Figure5: -Vds Drain-Source Voltage (V)

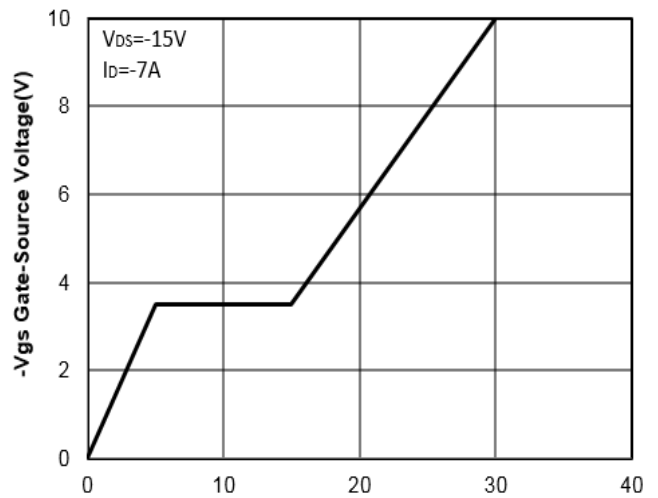

Figure6: Qg Gate Charge (nC)



-30V/-7A P-Channel Enhancement Mode Power MOSFET

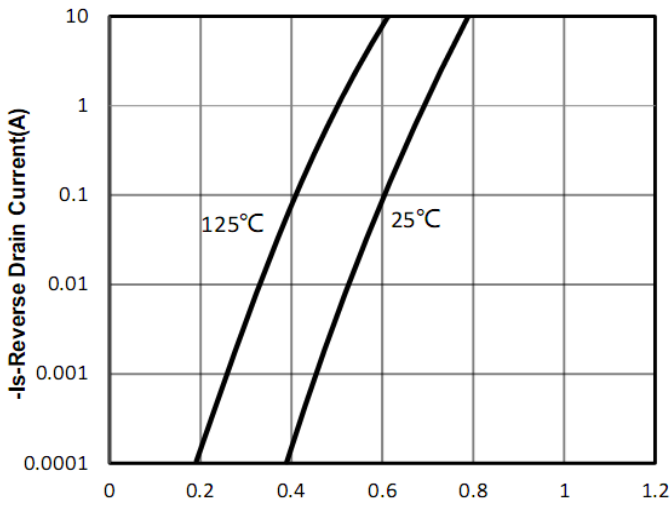

Figure7: -Vs Source-Drain Voltage (V)

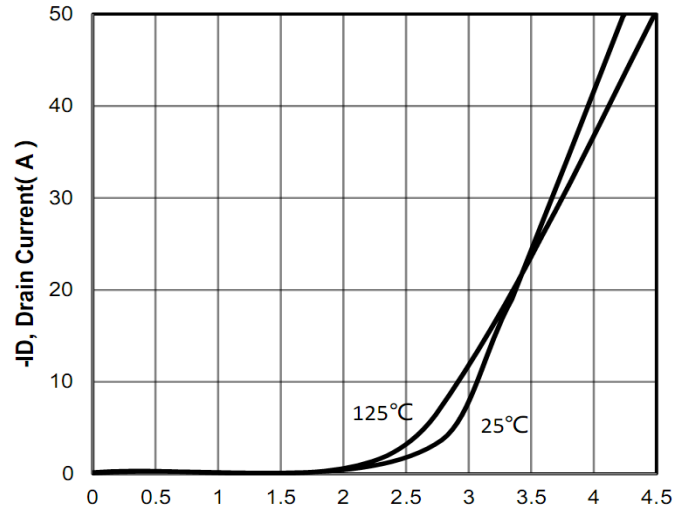

Figure8: -Vgs Gate-Source Voltage (V)

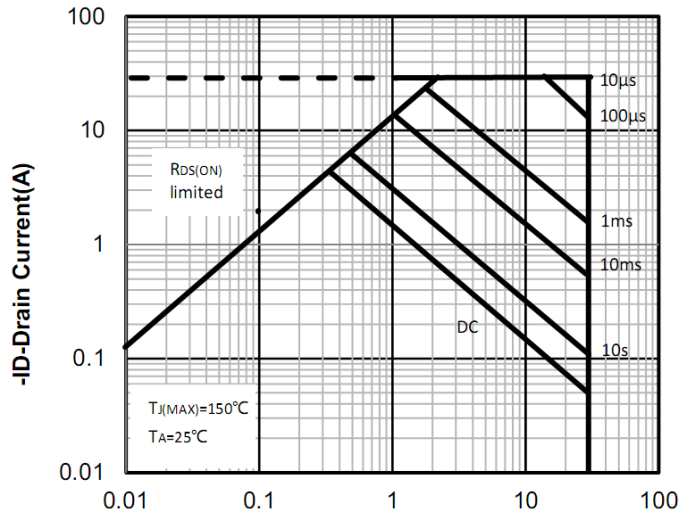

Figure9: -Vds Drain -Source Voltage (V)

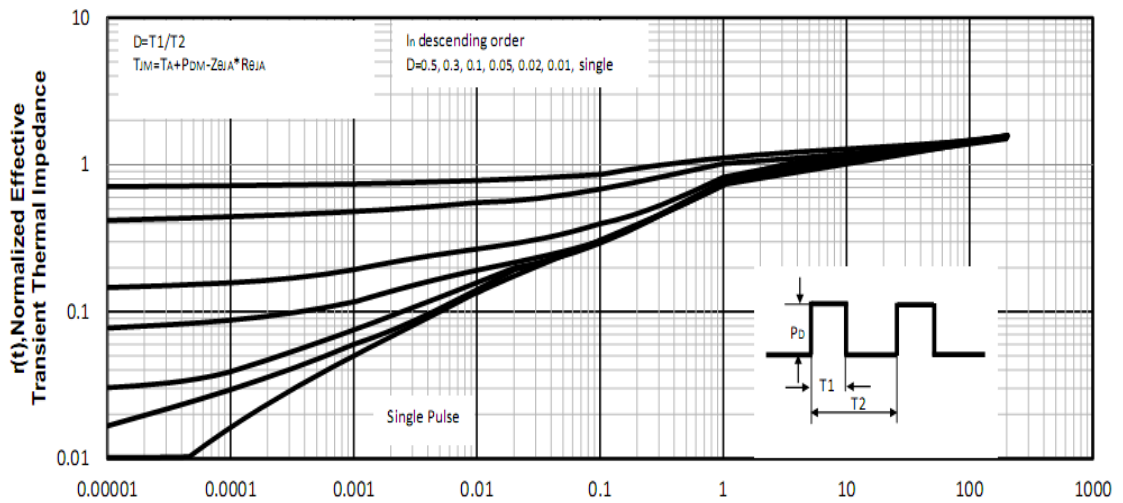

Figure10: Square Wave Pulse Duration (sec)

-30V/-7A P-Channel Enhancement Mode Power MOSFET

Test Circuit and Waveform:

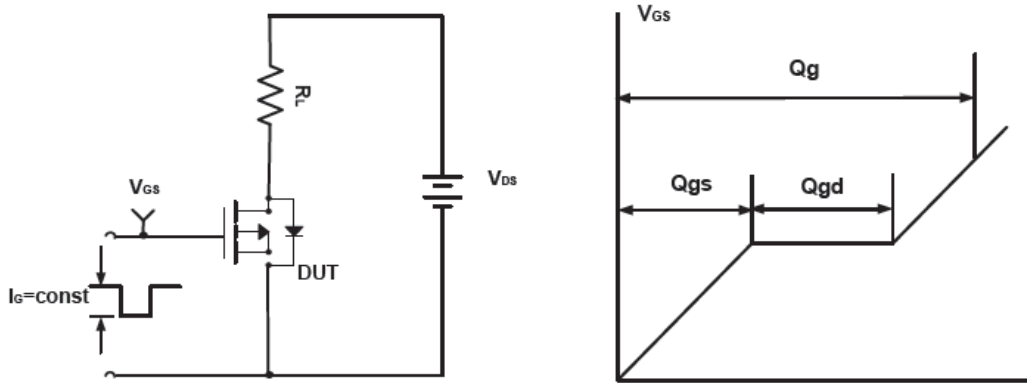

Figure A Gate Charge Test Circuit & Waveforms

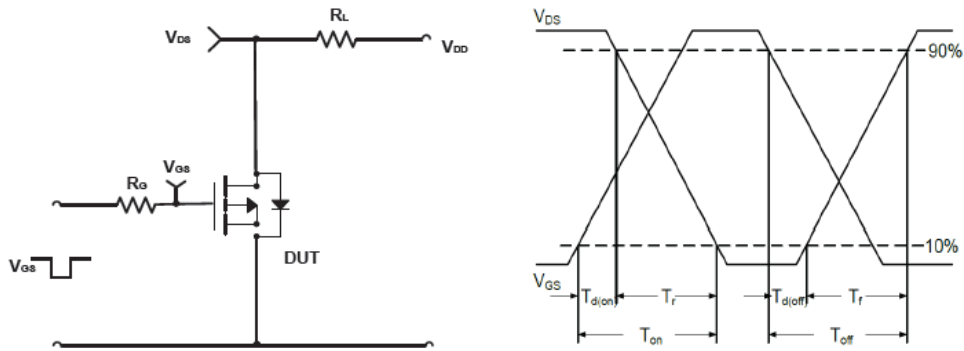

Figure B Switching Test Circuit & Waveforms

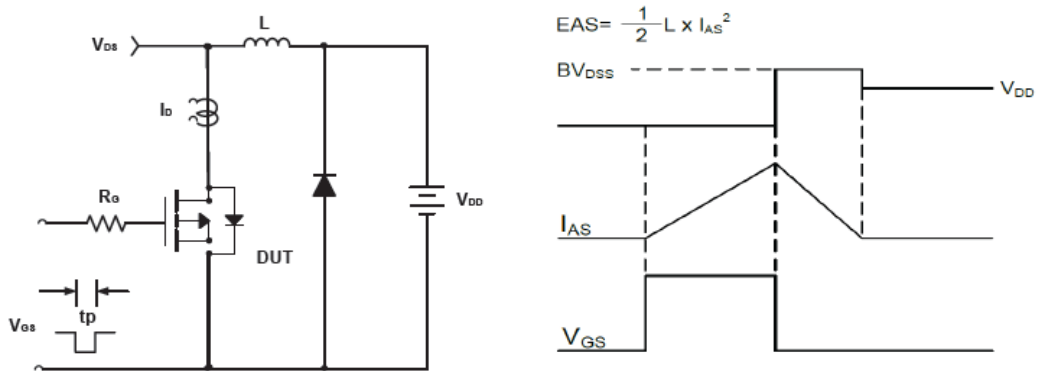
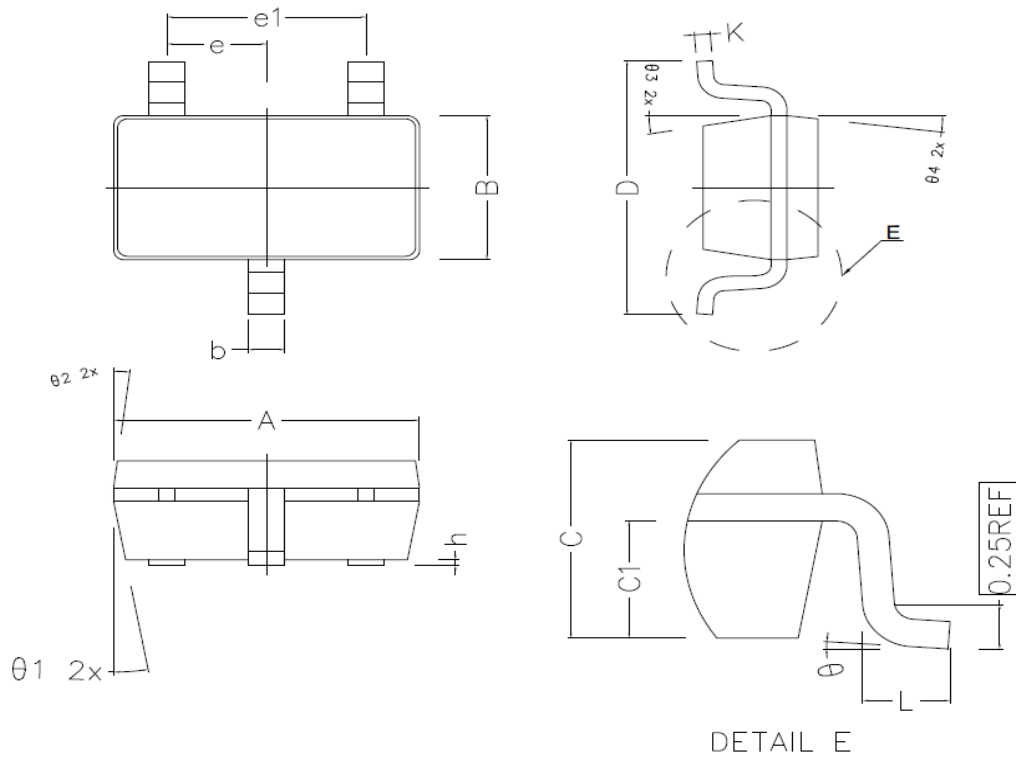

Figure C Unclamped Inductive Switching Circuit & Waveforms

-30V/-7A P-Channel Enhancement Mode Power MOSFET
SOT-23-3L Package Outline Dimensions (Units: mm)

COMMON DIMENSIONS (UNITS OF MEASURE IS mm)			
	MIN	NORMAL	MAX
A	2.820	2.920	3.020
B	1.500	1.600	1.700
C	1.050	1.100	1.150
C1	0.600	0.650	0.700
D	2.650	2.800	2.950
L	0.300	0.450	0.600
b	0.280	0.350	0.420
h	0.020	0.050	0.100
K	0.120	—	0.230
e	0.950TYPE		
e1	1.900TYPE		
θ_1	10° TYPE		
θ_2	7° TYPE		
θ_3	10° TYPE		
θ_4	7° TYPE		
θ	0° ~ 8°		