

**20V/6A N-Channel Enhancement Mode MOSFET****Features**

- High power and current handling capability
- Lead free product is acquired
- Surface mount package

**Applications**

- Low Switch
- PWM application

BVDSS	20	V
ID	6	A
RDSON@VGS=4.5V	13	mΩ
RDSON@VGS=2.5V	16	mΩ

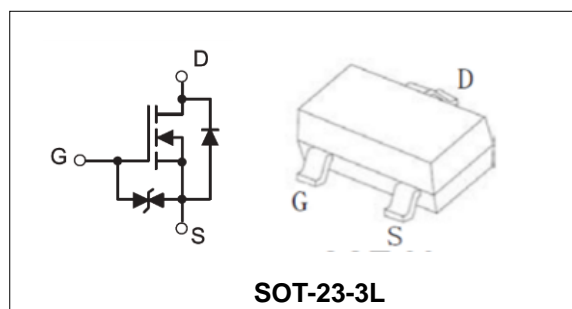
**Order Information**

Product	Package	Marking	Reel Size	Reel	Carton
PT3416	SOT-23-3L	AG6A	7inch	3000PCS	180000PCS

**Absolute Maximum Ratings**

Symbol	Parameter	Rating	Unit
<b>Common Ratings (TC=25°C Unless Otherwise Noted)</b>			
$V_{(BR)DSS}$	Drain-Source Breakdown Voltage	20	V
$V_{GS}$	Gate-Source Voltage	±12	V
$T_J$	Maximum Junction Temperature	150	°C
$T_{STG}$	Storage Temperature Range	-55 to 150	°C
$I_S$	Diode Continuous Forward Current	$T_A = 25^\circ\text{C}$ 6	A
<b>Mounted on Large Heat Sink</b>			
$I_{DM}$	Pulse Drain Current Tested (Silicon Limit) (Note1)	$T_A = 25^\circ\text{C}$ 30	A
$I_D$	Continuous Drain current	$T_A = 25^\circ\text{C}$ 6	A
$P_D$	Maximum Power Dissipation	$T_A = 25^\circ\text{C}$ 1.4	W
$R_{\theta JA}$	Thermal Resistance Junction-to-Ambient (Note2)	89.3	°C/W



## 20V/6A N-Channel Enhancement Mode MOSFET

Symbol	Parameter	Condition	Min.	Typ.	Max.	Unit
<b>Static Electrical Characteristics @ T<sub>J</sub> = 25°C (unless otherwise stated)</b>						
V <sub>(BR)DSS</sub>	Drain- Source Breakdown Voltage	VGS=0V ID=250μA	20	--	--	V
I <sub>DSS</sub>	Zero Gate Voltage Drain current	VDS=20V,VGS=0V	--	--	1	μA
I <sub>GSS</sub>	Gate-Body Leakage Current	VGS=±10V,VDS=0V	--	--	±10	uA
V <sub>GS(TH)</sub>	Gate Threshold Voltage	VDS=VGS,ID=250μA	0.45	0.7	1	V
R <sub>DS(ON)</sub>	Drain-Source On-State Resistance (Note3)	VGS=4.5V, ID=6A	--	13	22	mΩ
		VGS=2.5V, ID=5A	--	16	26	mΩ
<b>Dynamic Electrical Characteristics @ T<sub>J</sub> = 25°C (unless otherwise stated) (Note4)</b>						
C <sub>iss</sub>	Input Capacitance	VDS= 10V, VGS=0V, F=1MHz	--	660	--	pF
C <sub>oss</sub>	Output Capacitance		--	160	--	pF
C <sub>rss</sub>	Reverse Transfer Capacitance		--	87	--	pF
Q <sub>g</sub>	Total Gate Charge	VDS= 10V, ID= 6A, VGS= 4.5V	--	8	--	nC
Q <sub>gs</sub>	Gate-Source Charge		--	2.5	--	nC
Q <sub>gd</sub>	Gate-Drain Charge		--	3	--	nC
<b>Switching Characteristics (Note4)</b>						
t <sub>d(on)</sub>	Turn-on Delay Time	VDD=10V, RL=1.5Ω, RG=3Ω, VGS=5V	--	0.5	--	nS
t <sub>r</sub>	Turn-on Rise Time		--	1	--	nS
t <sub>d(off)</sub>	Turn-off Delay Time		--	12	--	nS
t <sub>f</sub>	Turn-off Fall Time		--	4	--	nS
<b>Source- Drain Diode Characteristics @ T<sub>J</sub> = 25°C (unless otherwise stated)</b>						
V <sub>SD</sub>	Forward on voltage (Note3)	IS=1A,VGS=0V	--	--	1.2	V

Note:

1. Repetitive Rating: Pulse width limited by maximum junction temperature.
2. Surface Mounted on FR4 Board, t ≤ 10 sec
3. Pulse Test: pulse width ≤ 300 us, duty cycle ≤ 2%.
4. Guaranteed by design, not subject to production testing.



20V/6A N-Channel Enhancement Mode MOSFET

Typical Characteristics

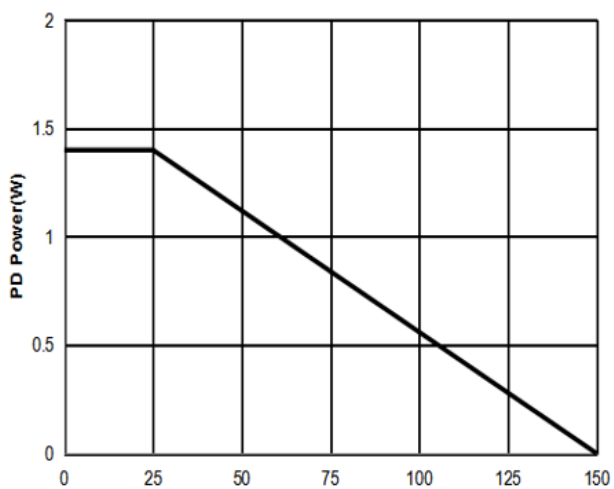

Figure1: T<sub>j</sub> Junction Temperature (°C)

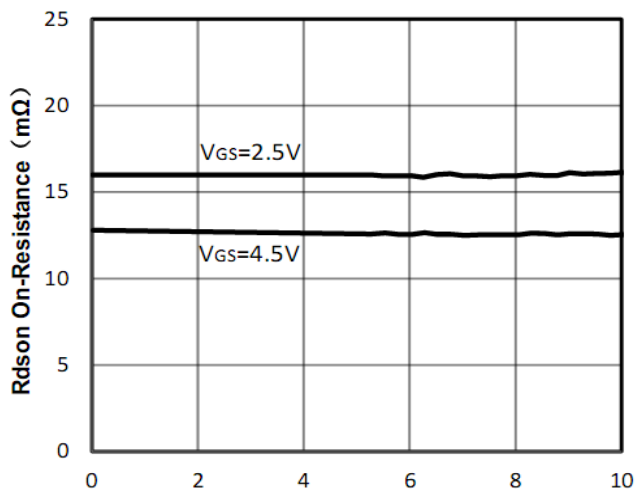

Figure2: I<sub>d</sub> Drain Current (A)

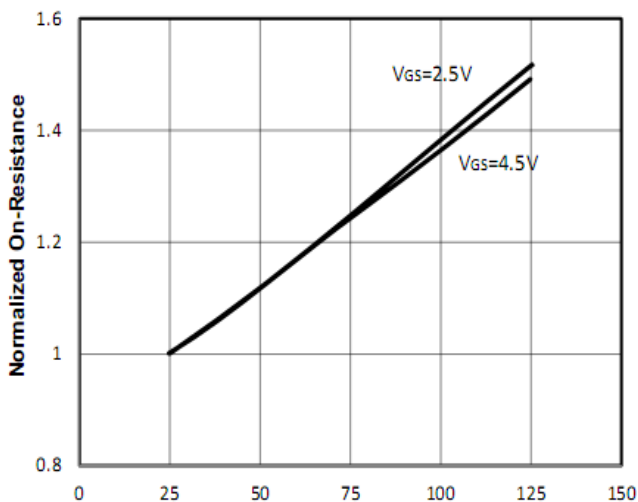

Figure3: T<sub>j</sub> Junction Temperature (°C)

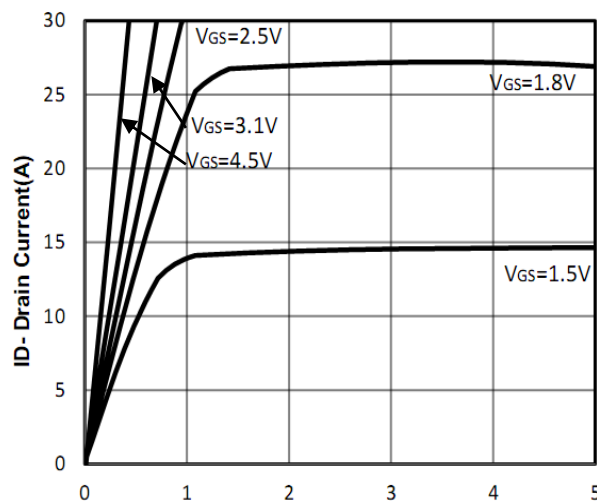

Figure4: V<sub>DS</sub> Drain-Source Voltage (V)

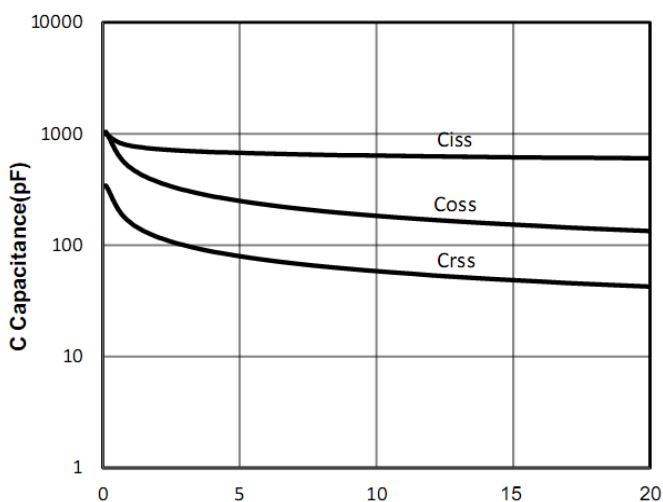

Figure5: V<sub>DS</sub> Drain-Source Voltage (V)

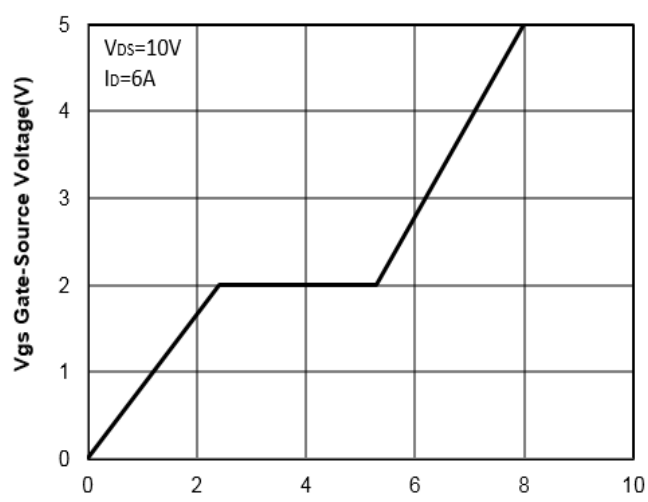

Figure6: Q<sub>g</sub> Gate Charge (nC)



20V/6A N-Channel Enhancement Mode MOSFET

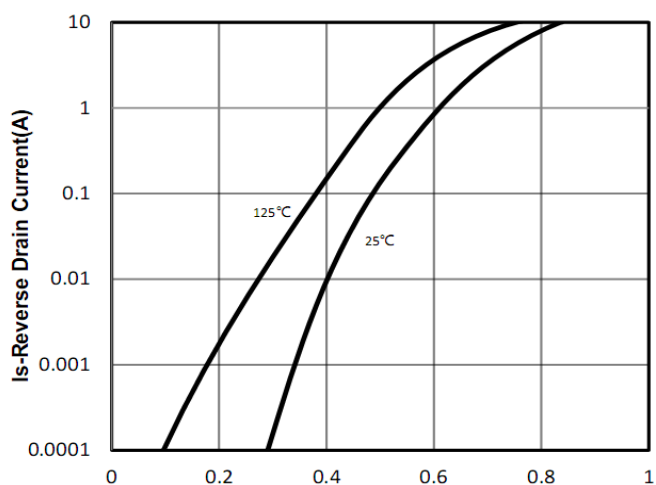

Figure7: Vsd Source-Drain Voltage (V)

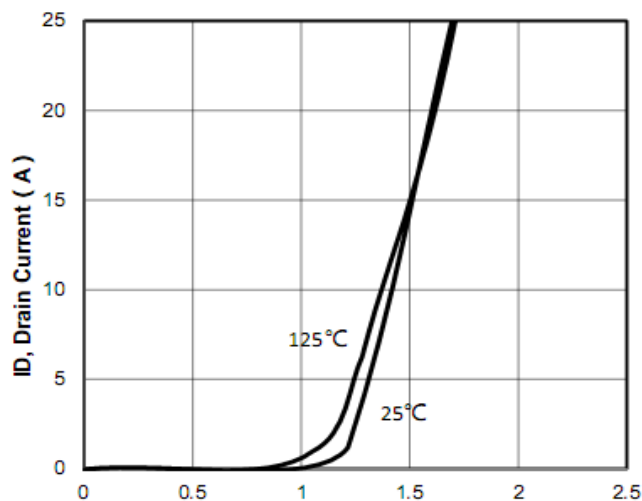

Figure8: Vgs Gate-Source Voltage (V)

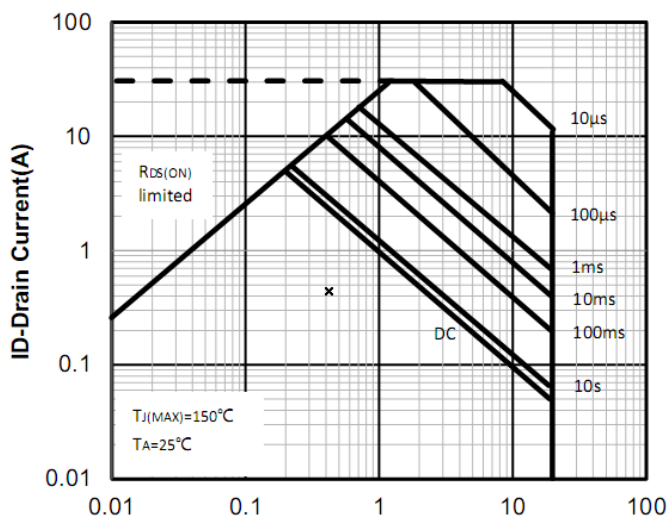

Figure9: Vds Drain-Source Voltage (V)

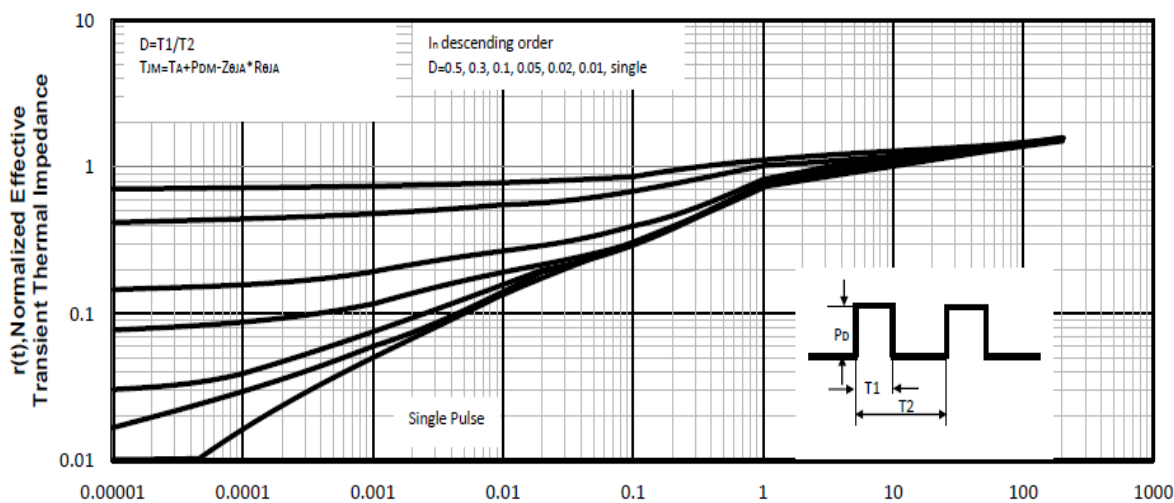
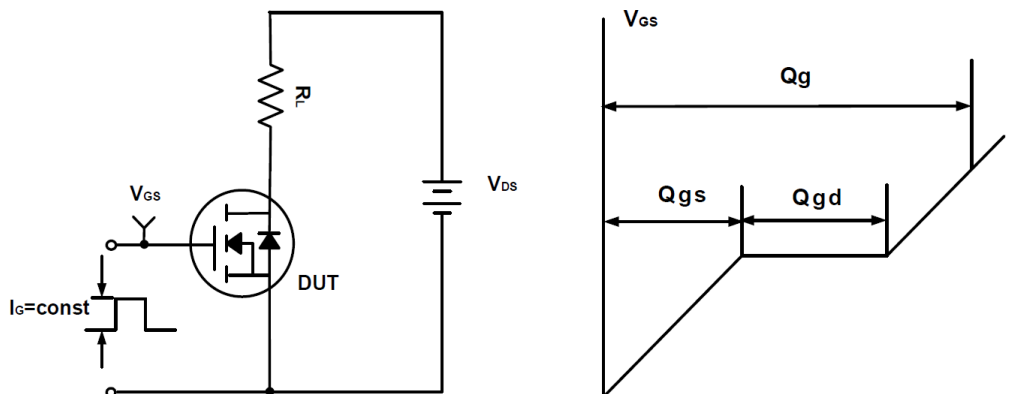
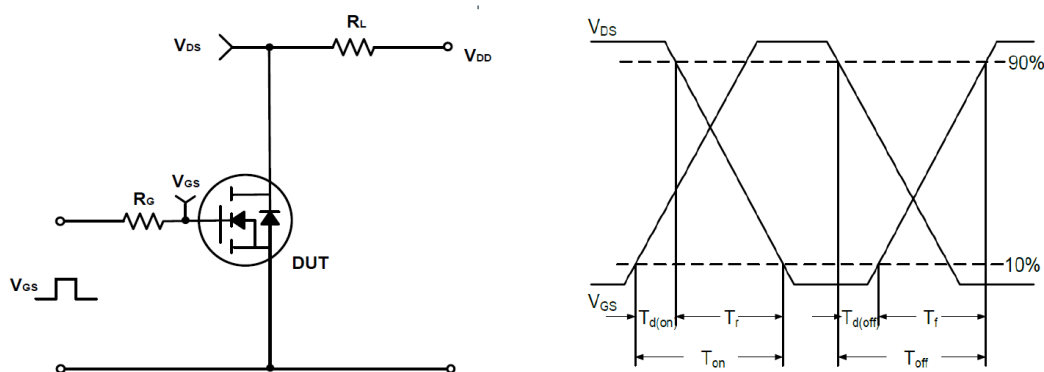
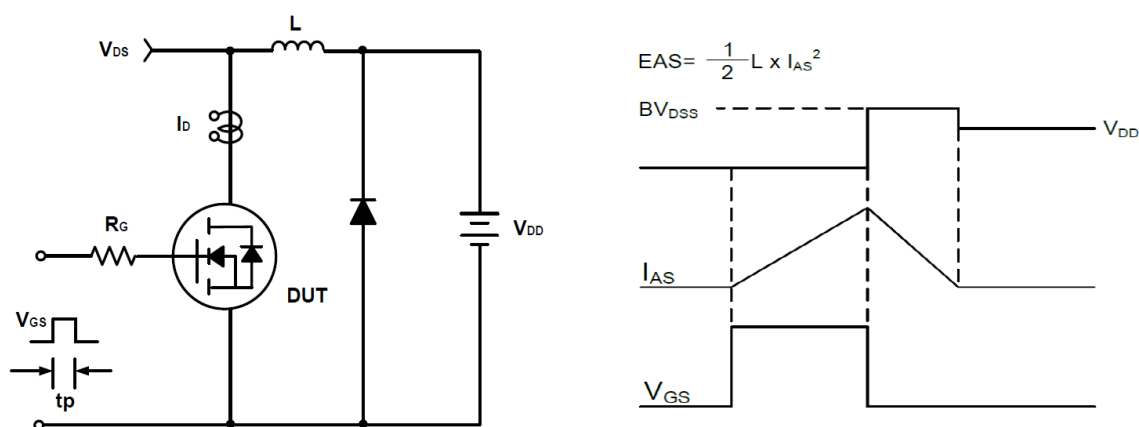
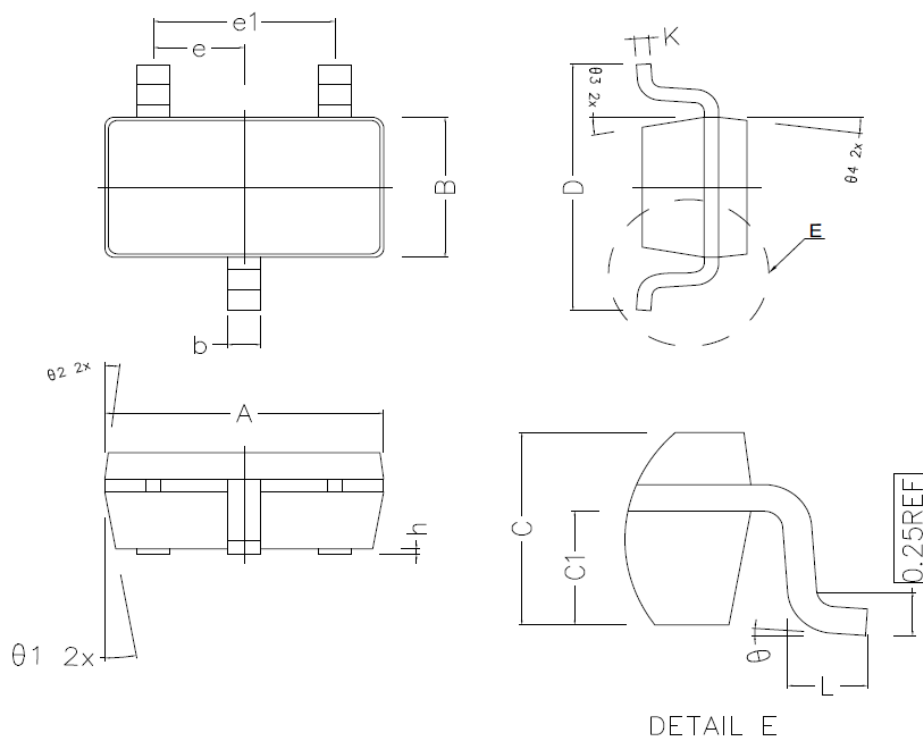

Figure10: Square Wave Pulse Duration (sec)

**20V/6A N-Channel Enhancement Mode MOSFET**
**Test Circuit and Waveform:**

**Figure A Gate Charge Test Circuit & Waveforms**

**Figure B Switching Test Circuit & Waveforms**

**Figure C Unclamped Inductive Switching Circuit & Waveforms**

**20V/6A N-Channel Enhancement Mode MOSFET**
**SOT-23-3L Package Outline Dimensions (Units: mm)**

COMMON DIMENSIONS (UNITS OF MEASURE IS mm)			
	MIN	NORMAL	MAX
A	2.820	2.920	3.020
B	1.500	1.600	1.700
C	1.050	1.100	1.150
C1	0.600	0.650	0.700
D	2.650	2.800	2.950
L	0.300	0.450	0.600
b	0.280	0.350	0.420
h	0.020	0.050	0.100
K	0.120	—	0.230
e	0.950TYPE		
e1	1.900TYPE		
$\theta1$	10° TYPE		
$\theta2$	7° TYPE		
$\theta3$	10° TYPE		
$\theta4$	7° TYPE		
$\theta$	0° ~ 8°		