

**30V/5.8A N-Channel Enhancement Mode MOSFET****Features**

- Advanced trench process technology
- High Density Cell Design For Ultra Low On-Resistance

**Applications**

- Low Side Load Switch
- Battery Switch
- Optimized for Power Management Applications for Portable Products, such as Aeromodelling, Power bank, Brushless motor, Main board , and Others

BVDSS	30	V
ID	5.8	A
RDSON@VGS=10V	22	mΩ
RDSON@VGS=4.5V	25	mΩ
RDSON@VGS=2.5V	33	mΩ

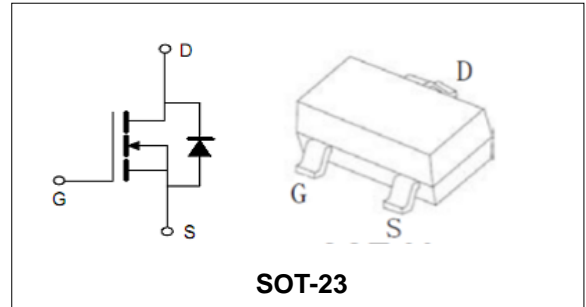
**Order Information**

Product	Package	Marking	Reel Size	Reel	Carton
PT3400	SOT-23	A07T	7inch	3000PCS	180000PCS

**Absolute Maximum Ratings**

Symbol	Parameter	Rating	Unit
<b>Common Ratings (TC=25°C Unless Otherwise Noted)</b>			
$V_{(BR)DSS}$	Drain-Source Breakdown Voltage	30	V
$V_{GS}$	Gate-Source Voltage	±12	V
$T_J$	Maximum Junction Temperature	150	°C
$T_{STG}$	Storage Temperature Range	-55 to 150	°C
$I_S$	Diode Continuous Forward Current	$T_A = 25^\circ\text{C}$ 5.8	A
<b>Mounted on Large Heat Sink</b>			
$I_{DM}$	Pulse Drain Current Tested (Silicon Limit) (Note1)	$T_A = 25^\circ\text{C}$ 30	A
$I_D$	Continuous Drain current	$T_A = 25^\circ\text{C}$ 5.8	A
$P_D$	Maximum Power Dissipation	$T_A = 25^\circ\text{C}$ 1.4	W
$R_{\theta JA}$	Thermal Resistance Junction-to-Ambient (Note2)	89.2	°C/W

**30V/5.8A N-Channel Enhancement Mode MOSFET**

Symbol	Parameter	Condition	Min.	Typ.	Max.	Unit
<b>Static Electrical Characteristics @ T<sub>J</sub> = 25°C (unless otherwise stated)</b>						
V <sub>(BR)DSS</sub>	Drain- Source Breakdown Voltage	VGS=0V ID=250μA	30	--	--	V
I <sub>DSS</sub>	Zero Gate Voltage Drain current	VDS=24V,VGS=0V	--	--	1	μA
I <sub>GSS</sub>	Gate-Body Leakage Current	VGS=±12V,VDS=0V	--	--	±100	nA
V <sub>GS(TH)</sub>	Gate Threshold Voltage	VDS=VGS,ID=250μA	0.7	--	1.4	V
R <sub>DS(ON)</sub>	Drain-Source On-State Resistance (Note3)	VGS=10V, ID=5.8A	--	22	28	mΩ
		VGS=4.5V, ID=5A	--	25	33	mΩ
		VGS=2.5V, ID=4A	--	33	52	mΩ
<b>Dynamic Electrical Characteristics @ T<sub>J</sub> = 25°C (unless otherwise stated) (Note4)</b>						
C <sub>iss</sub>	Input Capacitance	VDS= 15V, VGS=0V, F=1MHz	--	340	--	pF
C <sub>oss</sub>	Output Capacitance		--	115	--	pF
C <sub>rss</sub>	Reverse Transfer Capacitance		--	33	--	pF
Q <sub>g</sub>	Total Gate Charge	VDS= 15V, ID= 5.8A, VGS= 4.5V	--	11	--	nC
Q <sub>gs</sub>	Gate-Source Charge		--	1.6	--	nC
Q <sub>gd</sub>	Gate-Drain Charge		--	2.8	--	nC
<b>Switching Characteristics (Note4)</b>						
t <sub>d(on)</sub>	Turn-on Delay Time	VDD=15V, ID=1A, RG=3Ω, VGS=10V	--	7	--	nS
t <sub>r</sub>	Turn-on Rise Time		--	15	--	nS
t <sub>d(off)</sub>	Turn-off Delay Time		--	38	--	nS
t <sub>f</sub>	Turn-off Fall Time		--	3	--	nS
<b>Source- Drain Diode Characteristics @ T<sub>J</sub> = 25°C (unless otherwise stated)</b>						
V <sub>SD</sub>	Forward on voltage (Note3)	IS=3A,VGS=0V	--	--	1.2	V

Note:

1. Repetitive Rating: Pulse width limited by maximum junction temperature.
2. Surface Mounted on FR4 Board, t ≤ 10 sec
3. Pulse Test: pulse width ≤ 300 us, duty cycle ≤ 2%.
4. Guaranteed by design, not subject to production testing.



30V/5.8A N-Channel Enhancement Mode MOSFET

Typical Characteristics

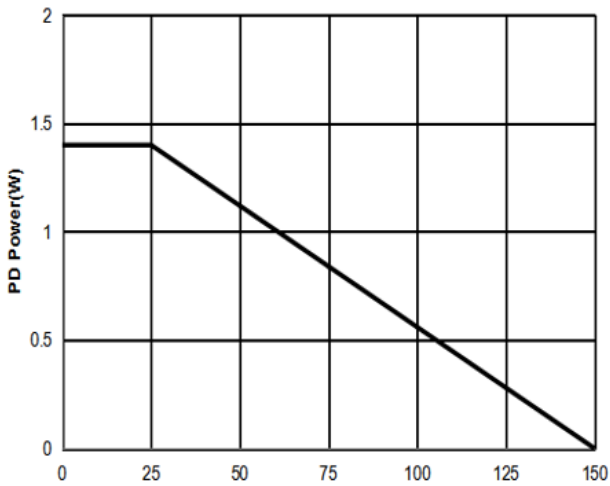

Figure1: Tj Junction Temperature (°C)

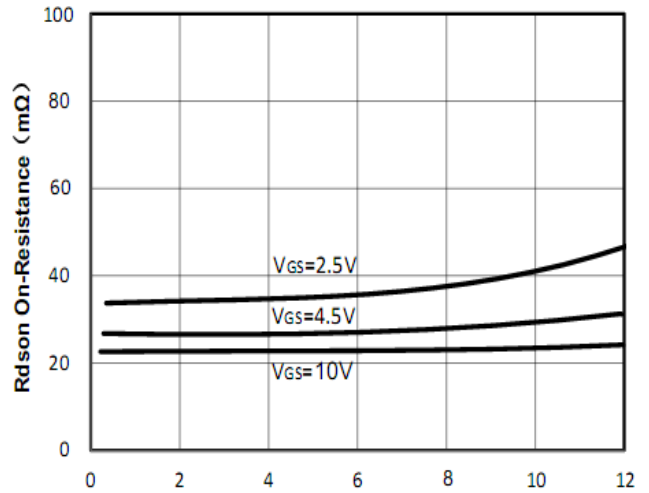

Figure2: Id Drain Current (A)

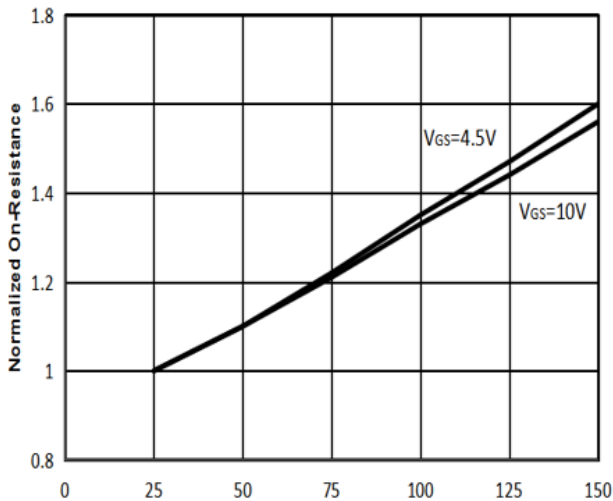

Figure3: Tj Junction Temperature (°C)

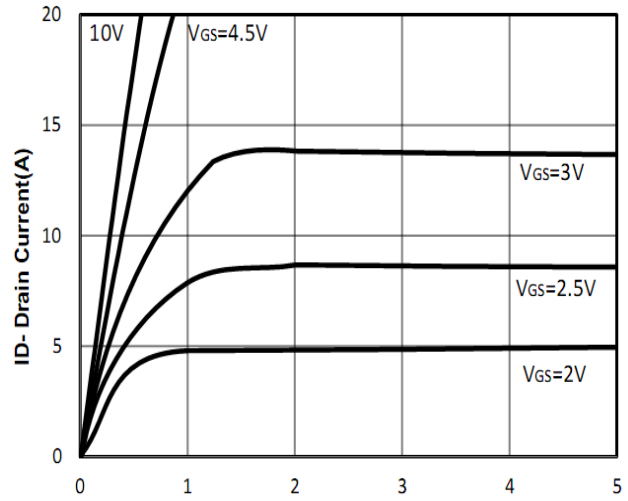

Figure4: Vds Drain-Source Voltage (V)

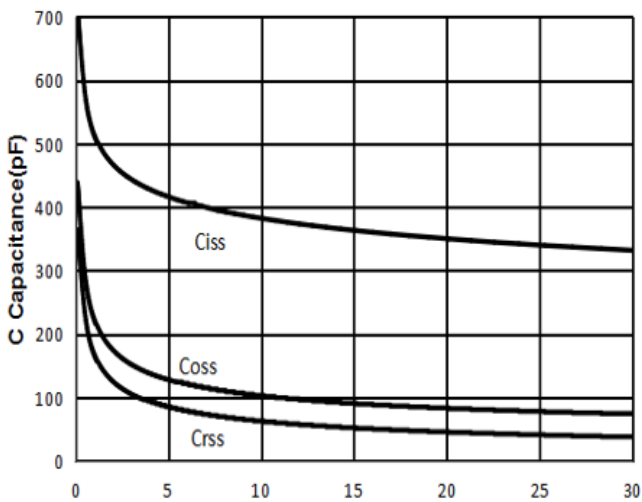

Figure5: Vds Drain-Source Voltage (V)

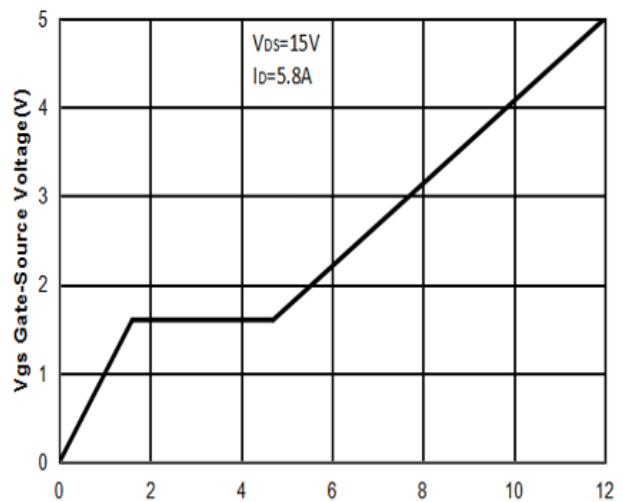

Figure6: Qg Gate Charge (nC)



30V/5.8A N-Channel Enhancement Mode MOSFET

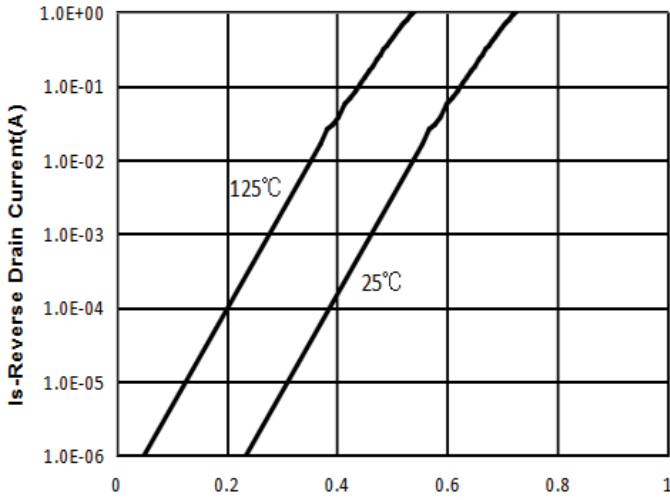

Figure7: Vsd Source-Drain Voltage (V)

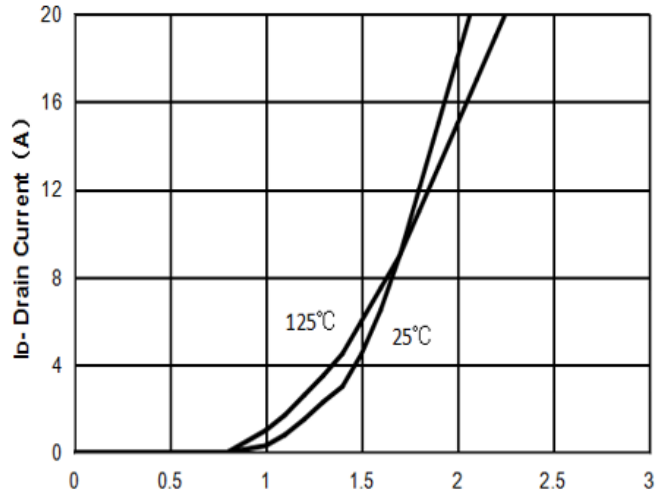

Figure8: Vgs Gate-Source Voltage (V)

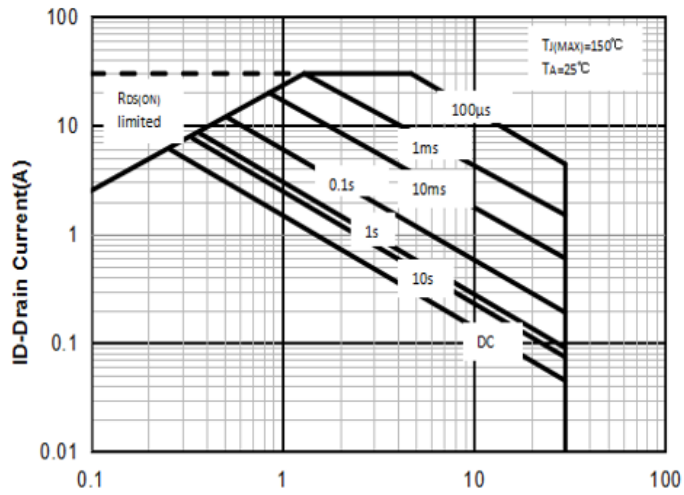

Figure9: Vds Drain -Source Voltage (V)

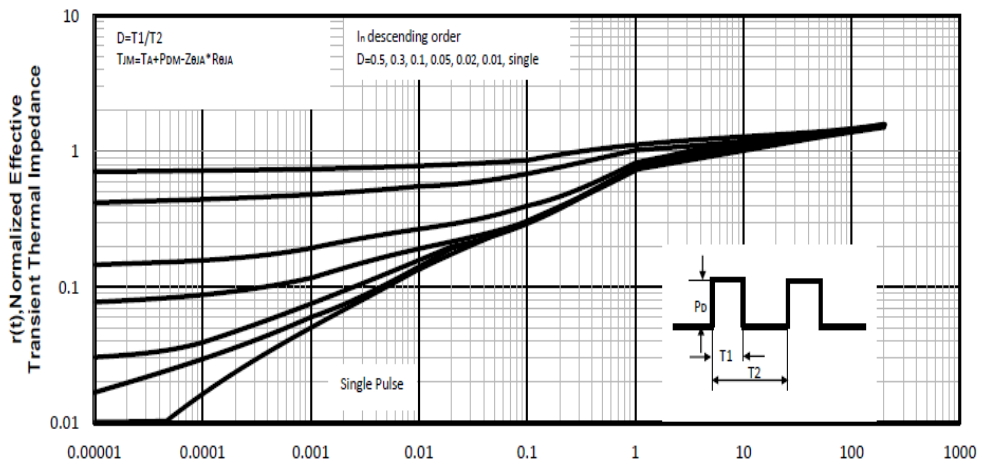
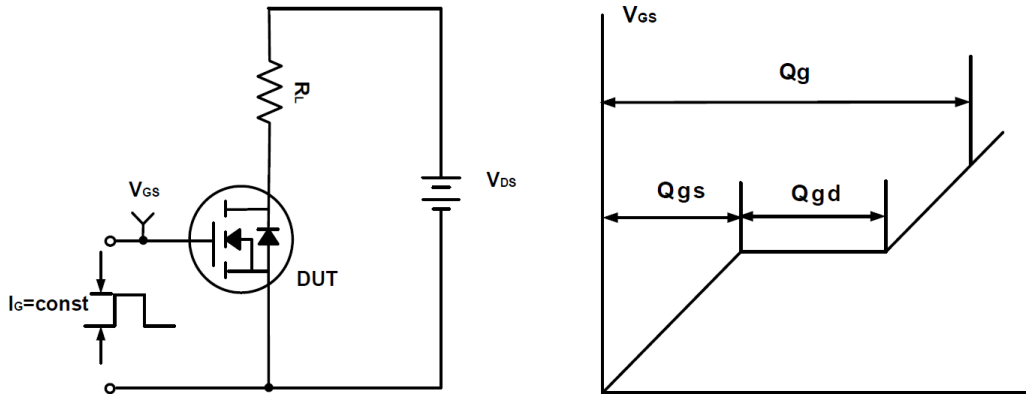
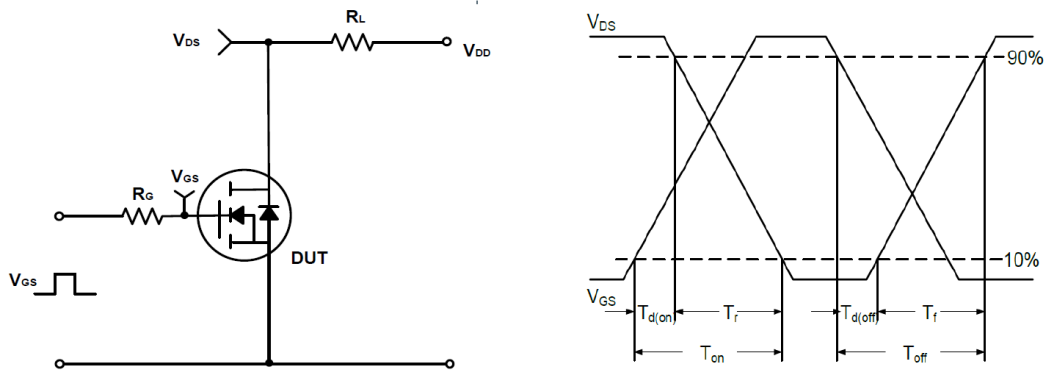
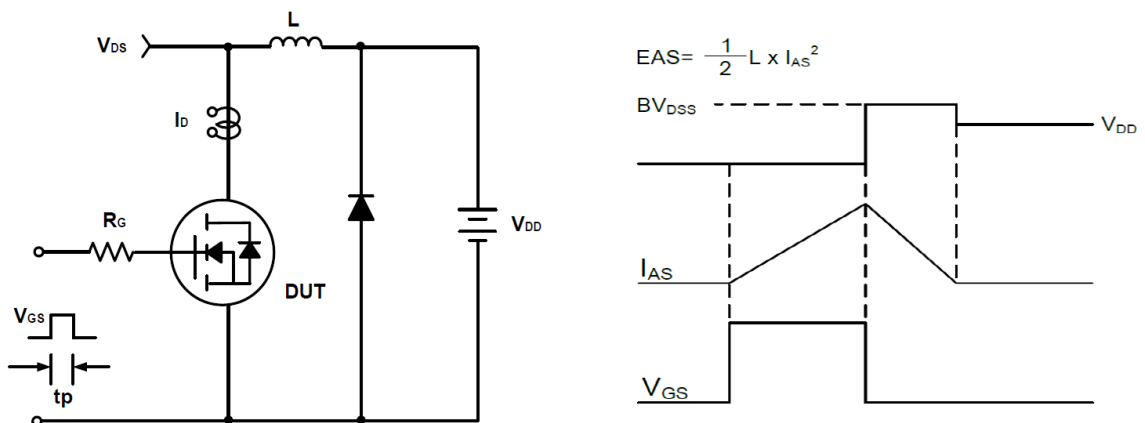
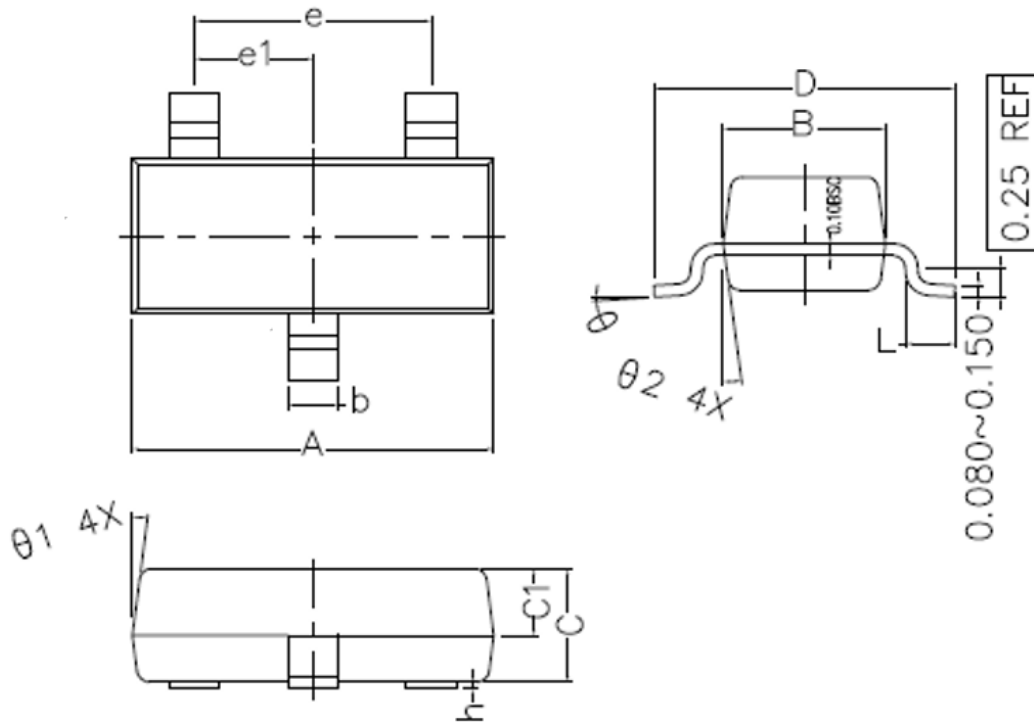

Figure10: Square Wave Pulse Duration (sec)

**30V/5.8A N-Channel Enhancement Mode MOSFET**
**Test Circuit and Waveform:**

**Figure A Gate Charge Test Circuit & Waveforms**

**Figure B Switching Test Circuit & Waveforms**

**Figure C Unclamped Inductive Switching Circuit & Waveforms**

**30V/5.8A N-Channel Enhancement Mode MOSFET**
**SOT-23 Package Outline Dimensions (Units: mm)**

COMMON DIMENSIONS (UNITS OF MEASURE IS mm)			
	MIN	NORMAL	MAX
A	2.800	2.900	3.000
B	1.200	1.300	1.400
C	0.900	1.000	1.100
C1	0.500	0.550	0.600
D	2.250	2.400	2.550
L	0.300	0.400	0.500
h	0.010	0.050	0.100
b	0.300	0.400	0.500
e	1.90 TYPE		
e1	0.95 TYPE		
$\theta_1$	7° TYPE		
$\theta_2$	7° TYPE		
$\theta$	0° ~ 7°		