



N And P- Channel Enhancement Mode Power MOSSFET

Features

- Low RDS(on) @VGS=5V
- 5V Logic Level Control
- N+P Dual Channel PDFN5X6-8L Package
- Pb-Free, RoHS Compliant

Applications

- DC Fan
- Brushless motor
- Optimized for Power Management Applications for Portable Products, such as H-bridge, Inverters Car Charger and Others

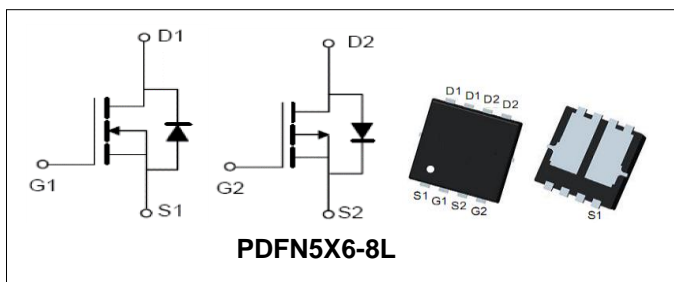

N-Channel		
BVDSS	60	V
ID	6	A
RDSON@VGS=10V	29	mΩ
RDSON@VGS=4.5V	32	mΩ

P-Channel		
BVDSS	-60	V
ID	-5	A
RDSON@VGS=-10V	68	mΩ
RDSON@VGS=-5V	81	mΩ

Order Information

Product	Package	Marking	Reel Size	Reel	Carton
PTN05C06	PDFN5X6-8L	PTN05C06	13inch	5000PCS	80000PCS

Absolute Maximum Ratings

Symbol	Parameter		N-Channel	P-Channel	Unit
Common Ratings (TC=25°C Unless Otherwise Noted)					
V _{(BR)DSS}	Drain-Source Breakdown Voltage		60	-60	V
V _{GS}	Gate-Source Voltage		±20	±20	V
T _J	Maximum Junction Temperature		150		°C
T _{STG}	Storage Temperature Range		-50 to 150		°C
I _S	Diode Continuous Forward Current (Note1)	TC =25°C	6	-5	A
Mounted on Large Heat Sink					
I _{DM}	Pulse Drain Current Tested (Silicon Limit) (Note1)	TC =25°C	24	-20	A
I _D	Continuous Drain current	TC =25°C	6	-6	A
P _D	Maximum Power Dissipation	TC =25°C	2		W
R _{θJC}	Thermal Resistance Junction-to-Case (Note2)		6.25		°C/W



N And P- Channel Enhancement Mode Power MOSSFET

N-Channel Electrical Characteristics

Symbol	Parameter	Condition	Min.	Typ.	Max.	Unit
Static Electrical Characteristics @ T_J = 25°C (unless otherwise stated)						
V _{(BR)DSS}	Drain- Source Breakdown Voltage	VGS=0V ID=250μA	60	--	--	V
I _{DSS}	Zero Gate Voltage Drain current	VDS=30V,VGS=0V	--	--	1	μA
I _{GSS}	Gate-Body Leakage Current	VGS=±20V,VDS=0V	--	--	±100	nA
V _{GS(TH)}	Gate Threshold Voltage	VDS=VGS,ID=250μA	1	1.6	2.5	V
R _{DS(ON)}	Drain-Source On-State Resistance (Note3)	VGS=10V, ID=6A	--	29	35	mΩ
		VGS=4.5V, ID=10A	--	32	38	mΩ
Dynamic Electrical Characteristics @ T_J = 25°C (unless otherwise stated) (Note4)						
C _{iss}	Input Capacitance	VDS= 30V, VGS=0V, F=1MHz	--	1310	--	pF
C _{oss}	Output Capacitance		--	59.5	--	pF
C _{rss}	Reverse Transfer Capacitance		--	44.3	--	pF
Q _g	Total Gate Charge	VDS= 30V, ID= 6A, VGS= 10V	--	31	--	nC
Q _{gs}	Gate-Source Charge		--	6	--	nC
Q _{gd}	Gate-Drain Charge		--	8	--	nC
Switching Characteristics (Note4)						
t _{d(on)}	Turn-on Delay Time	VDD=30V, ID=6A, VGS=10V, RG=3Ω	--	6	--	nS
t _r	Turn-on Rise Time		--	11	--	nS
t _{d(off)}	Turn-off Delay Time		--	19	--	nS
t _f	Turn-off Fall Time		--	5	--	nS
Source- Drain Diode Characteristics @ T_J = 25°C (unless otherwise stated)						
V _{SD}	Forward on voltage	IS=5A,VGS=0V	--	0.82	1.2	V



N And P- Channel Enhancement Mode Power MOSSFET

P-Channel Electrical Characteristics

Symbol	Parameter	Condition	Min.	Typ.	Max.	Unit
Static Electrical Characteristics @ T_J = 25°C (unless otherwise stated)						
V _{(BR)DSS}	Drain- Source Breakdown Voltage	VGS=0V ID=-250μA	-60	--	--	V
I _{DSS}	Zero Gate Voltage Drain current	VDS=-30V, VGS=0V	--	--	1	μA
I _{GSS}	Gate-Body Leakage Current	VGS=±20V, VDS=0V	--	--	±100	nA
V _{GS(TH)}	Gate Threshold Voltage	VDS=VGS, ID=-250μA	-1.0	-2	-2.5	V
R _{DS(ON)}	Drain-Source On-State Resistance (Note3)	VGS=-10V, ID=-10.5A	--	68	75	mΩ
		VGS=-5V, ID=-6A	--	81	95	mΩ
Dynamic Electrical Characteristics @ T_J = 25°C (unless otherwise stated) (Note4)						
C _{iss}	Input Capacitance	VDS= -30V, VGS=0V, F=1MHz	--	1210	--	pF
C _{oss}	Output Capacitance		--	779	--	pF
C _{rss}	Reverse Transfer Capacitance		--	387	--	pF
Q _g	Total Gate Charge	VDS= 30V, ID= 5A, VGS= -10V	--	6	--	nC
Q _{gs}	Gate-Source Charge		--	5.1	--	nC
Q _{gd}	Gate-Drain Charge		--	7.9	--	nC
Switching Characteristics (Note4)						
t _{d(on)}	Turn-on Delay Time	VDD=- 30V, ID=-5A, VGS=-10V, RG=3Ω	--	8	--	nS
t _r	Turn-on Rise Time		--	10.1	--	nS
t _{d(off)}	Turn-off Delay Time		--	59	--	nS
t _f	Turn-off Fall Time		--	27	--	nS
Source- Drain Diode Characteristics @ T_J = 25°C (unless otherwise stated)						
V _{SD}	Forward on voltage (Note3)	IS=-5A, VGS=0V	--	-0.8	-1.2	V

Note:

1. Repetitive Rating: Pulse width limited by maximum junction temperature.
2. Surface Mounted on FR4 Board, t ≤ 10 sec
3. Pulse Test: pulse width ≤ 300 us, duty cycle ≤ 2%.
4. Guaranteed by design, not subject to production testing.



N And P- Channel Enhancement Mode Power MOSSFET

Typical Characteristics (N-Channel)

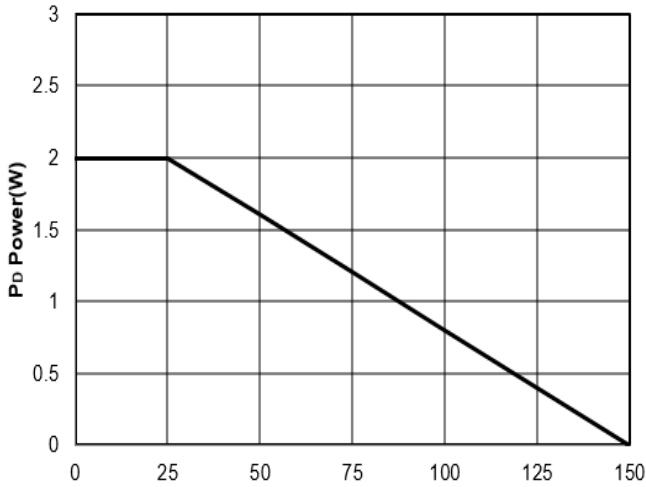

Figure1: Tj Junction Temperature (°C)

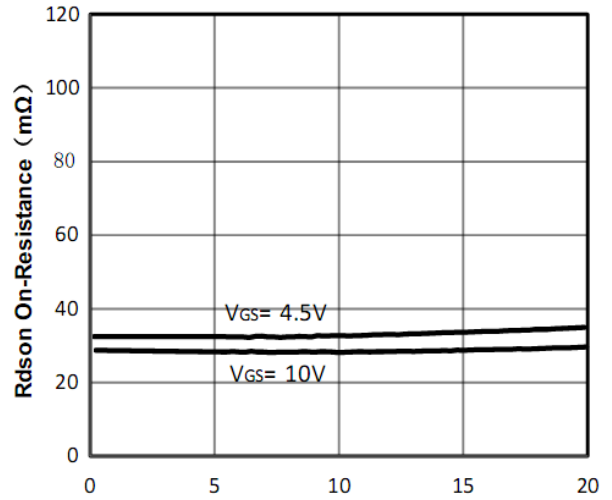

Figure2: Id Drain Current (A)

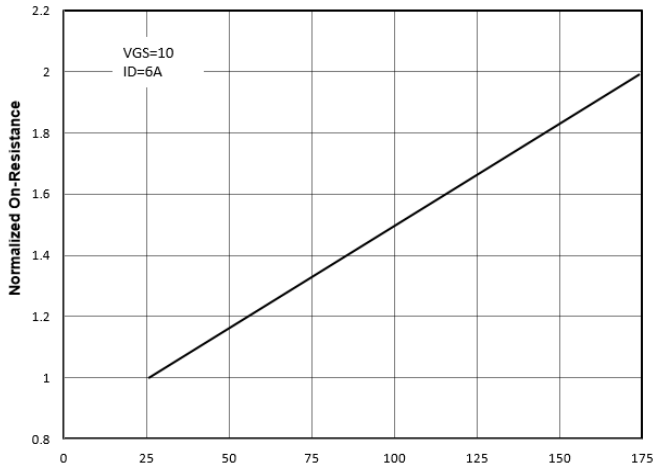

Figure3: Tj Junction Temperature (°C)

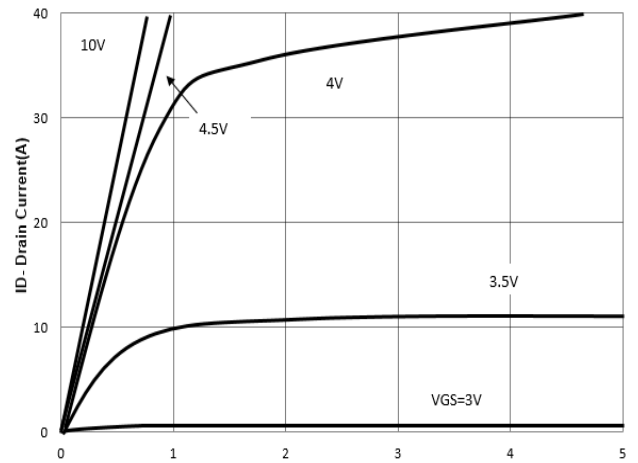

Figure4: Vds Drain-Source Voltage (V)

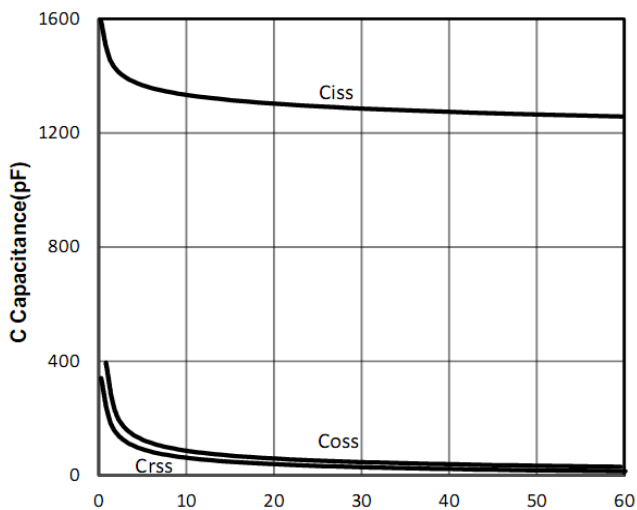

Figure5: Vds Drain-Source Voltage (V)

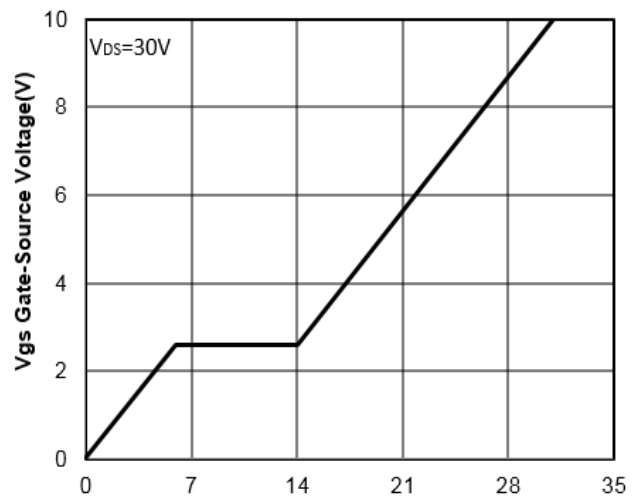

Figure6: Qg Gate Charge (nC)



N And P- Channel Enhancement Mode Power MOSSFET

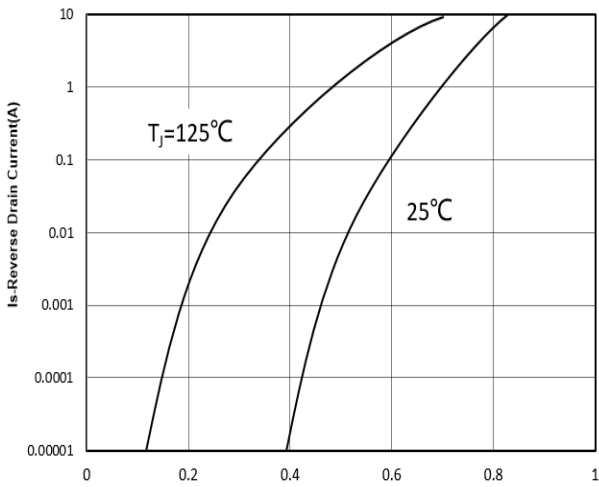

Figure7: Vsd Source-Drain Voltage (V)

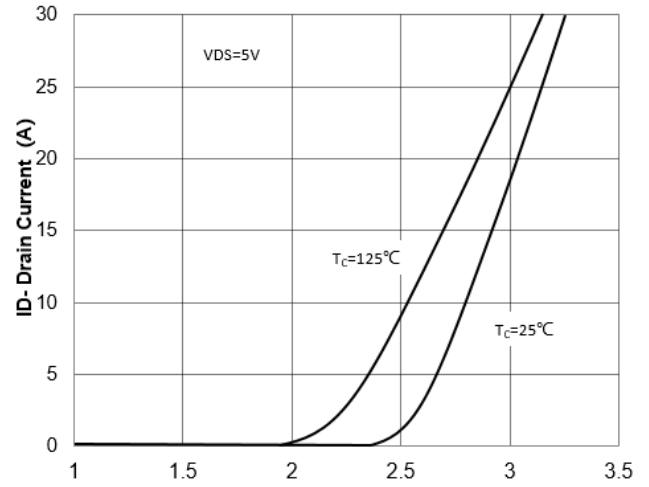

Figure8: Vgs Gate-Source Voltage (V)

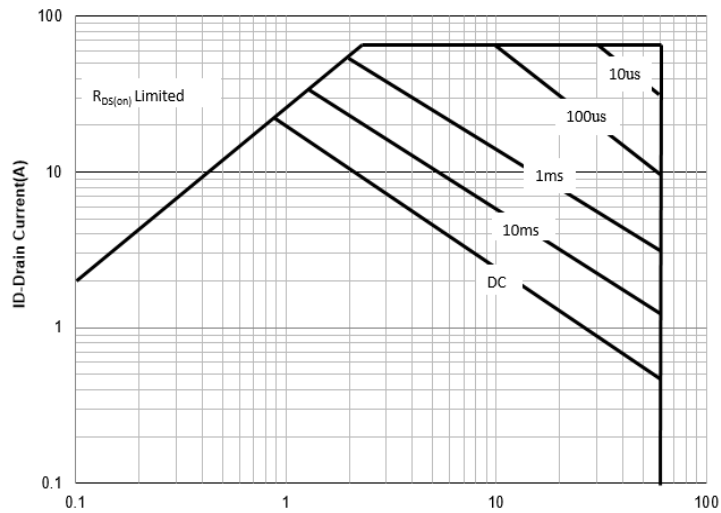

Figure9: VDS Drain -Source Voltage (V)

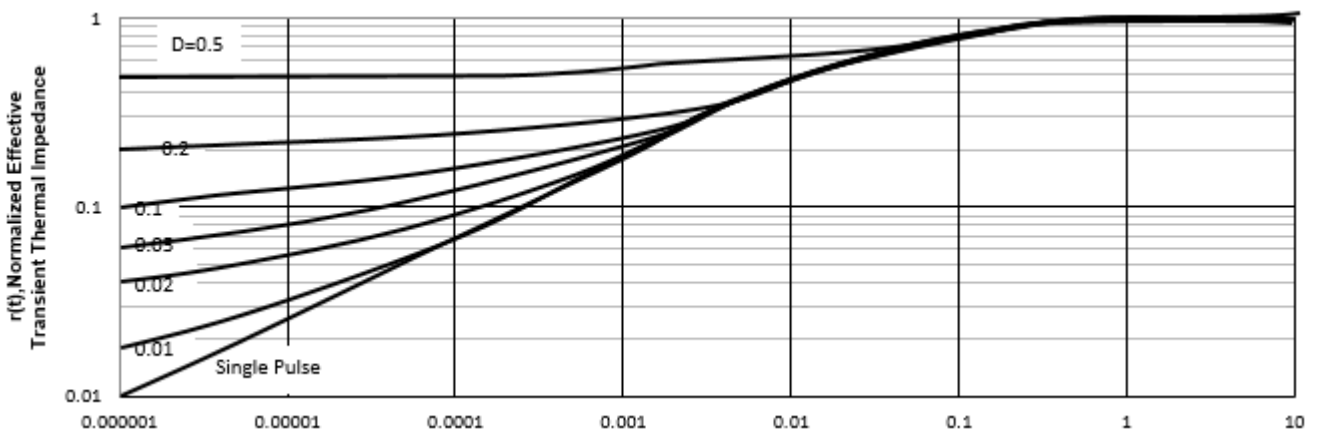

Figure10: Square Wave Pulse Duration (sec)

N And P- Channel Enhancement Mode Power MOSSFET

Test Circuit and Waveform(N-Channel):

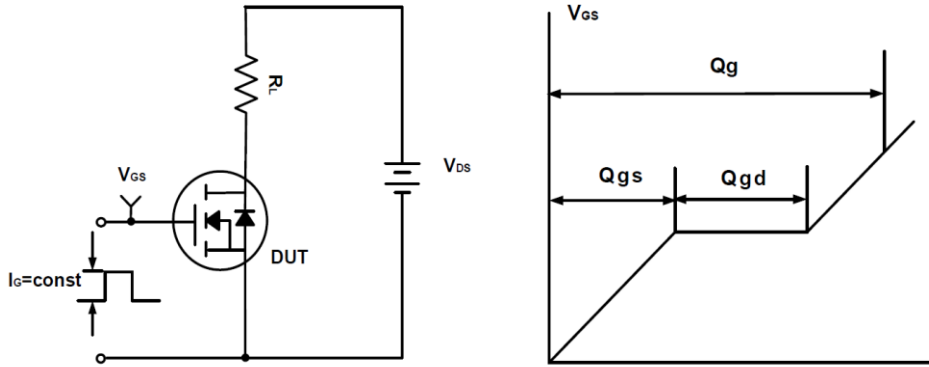

Figure A Gate Charge Test Circuit & Waveforms

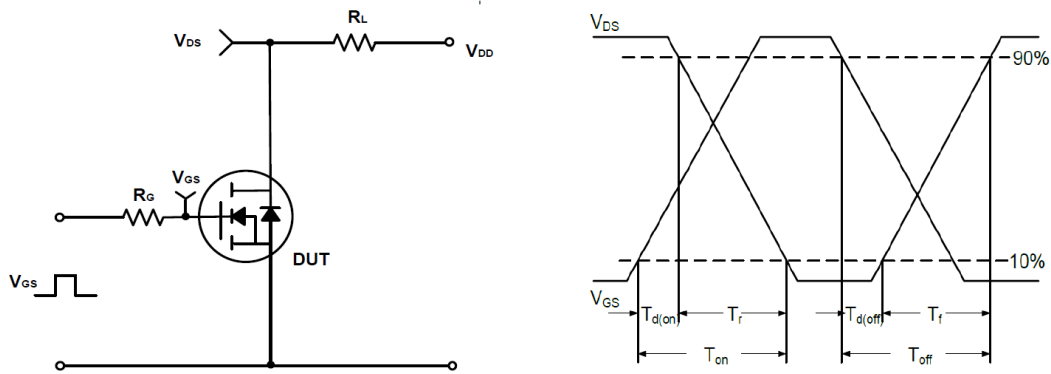

Figure B Switching Test Circuit & Waveforms

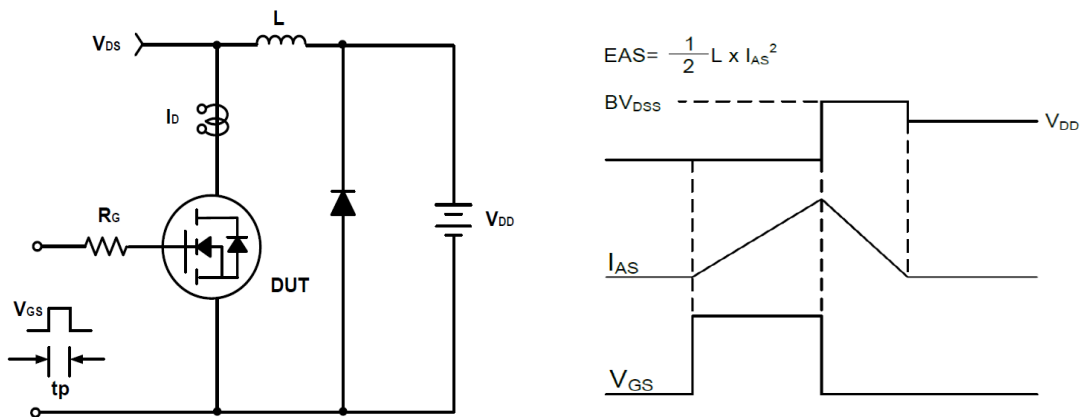

Figure C Unclamped Inductive Switching Circuit & Waveforms



N And P- Channel Enhancement Mode Power MOSSFET

Typical Characteristics(P-Channel)

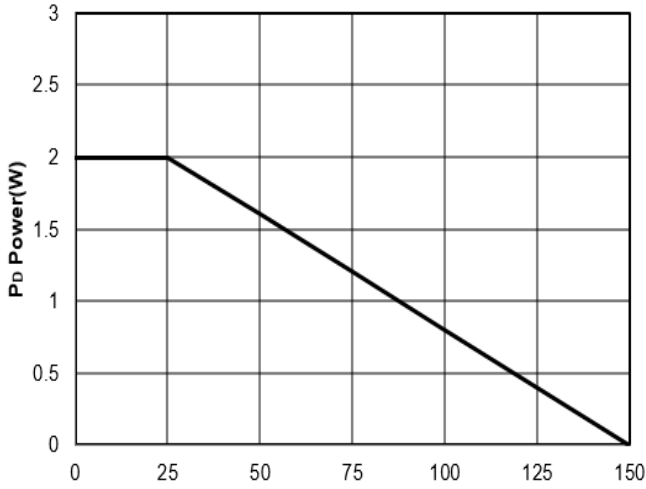

Figure1: Tj Junction Temperature (°C)

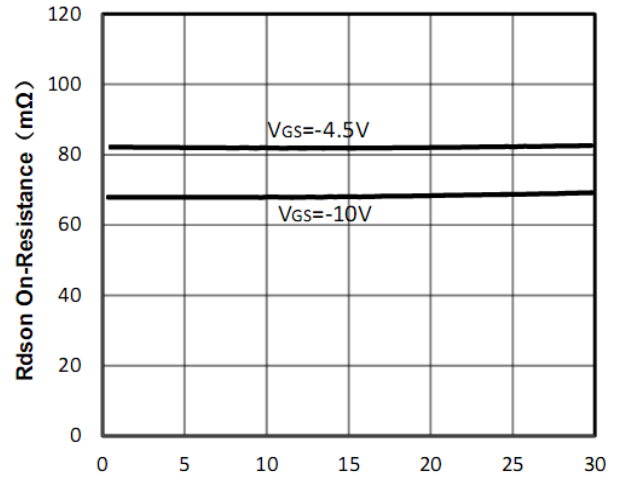

Figure2: -Id Drain Current (A)

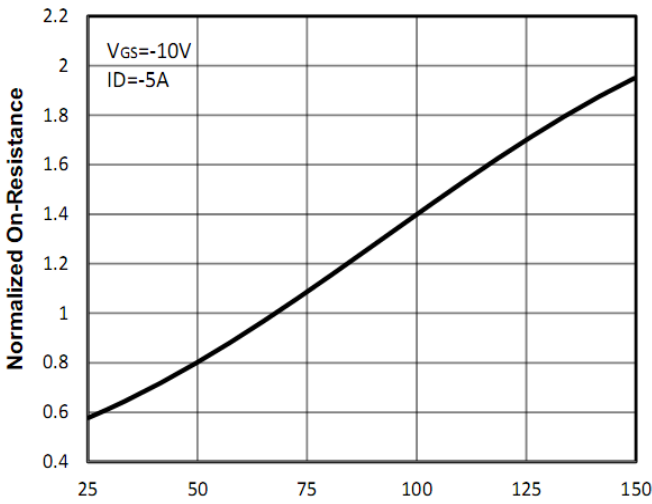

Figure3: Tj Junction Temperature (°C)

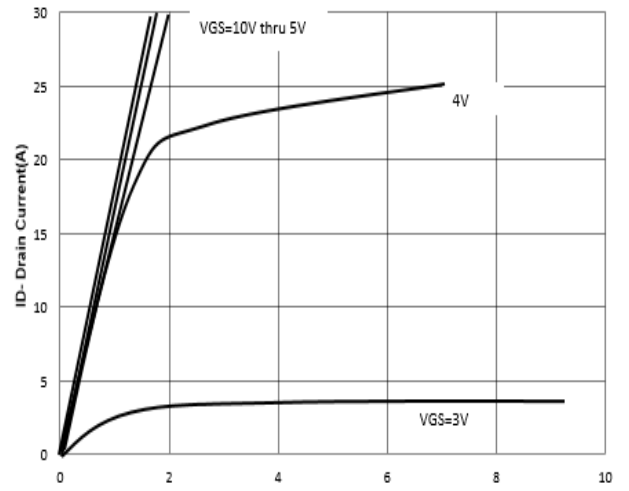

Figure4: -Vds Drain-Source Voltage (V)

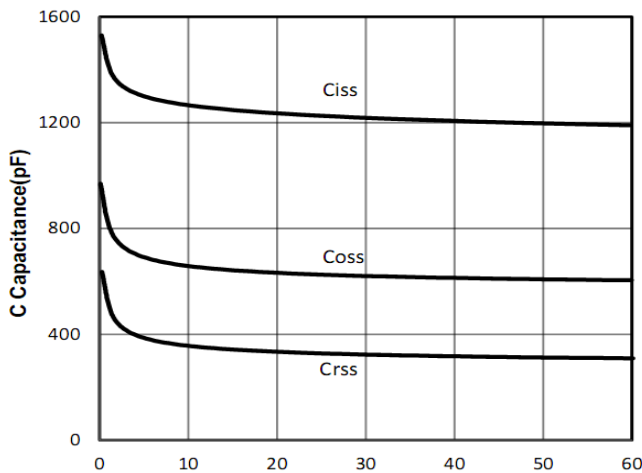

Figure5: -Vds Drain-Source Voltage (V)

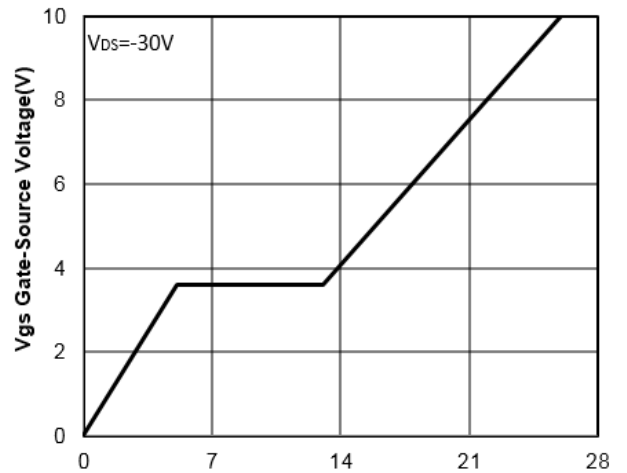

Figure6: Qg Gate Charge (nC)



N And P- Channel Enhancement Mode Power MOSSFET

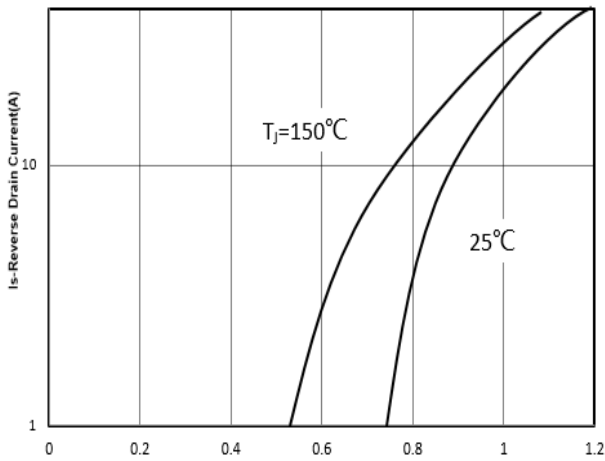

Figure7: -Vsd Source-Drain Voltage (V)

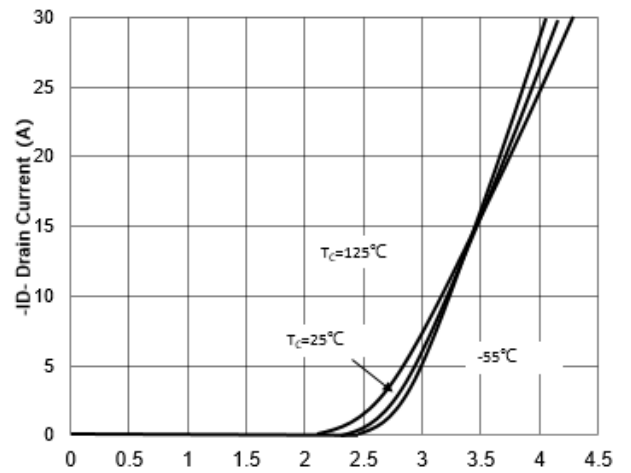

Figure8: -Vgs Gate-Source Voltage (V)

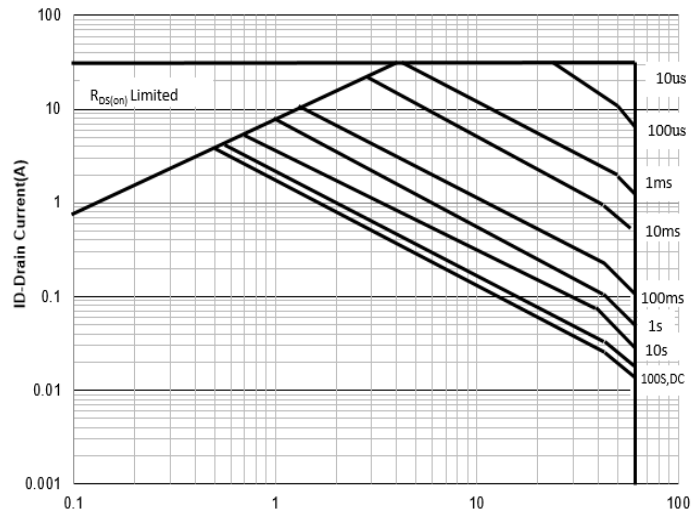

Figure9: -Vds Drain -Source Voltage (V)

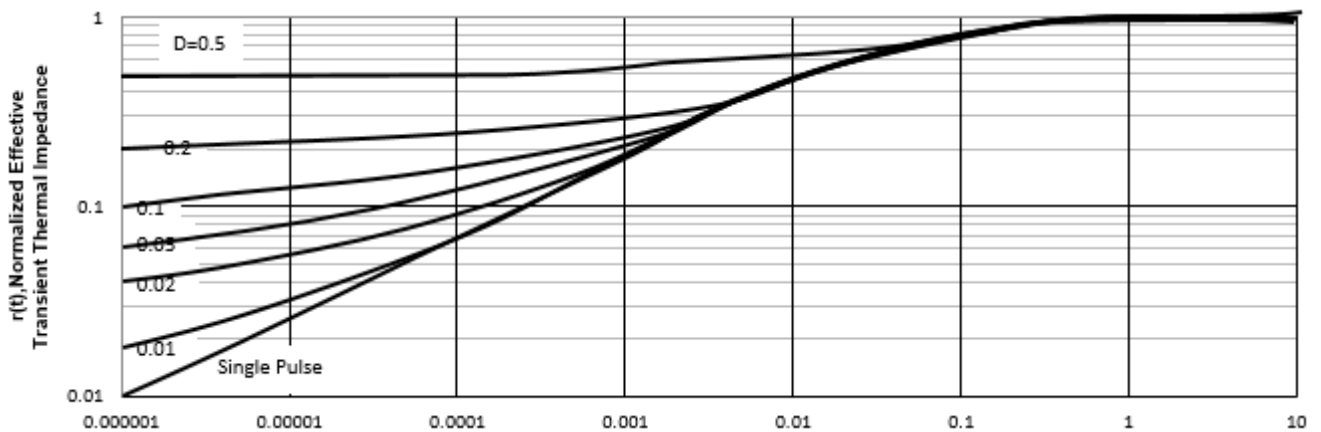

Figure10: Square Wave Pulse Duration (sec)

N And P- Channel Enhancement Mode Power MOSSFET

Test Circuit and Waveform(P-Channel):

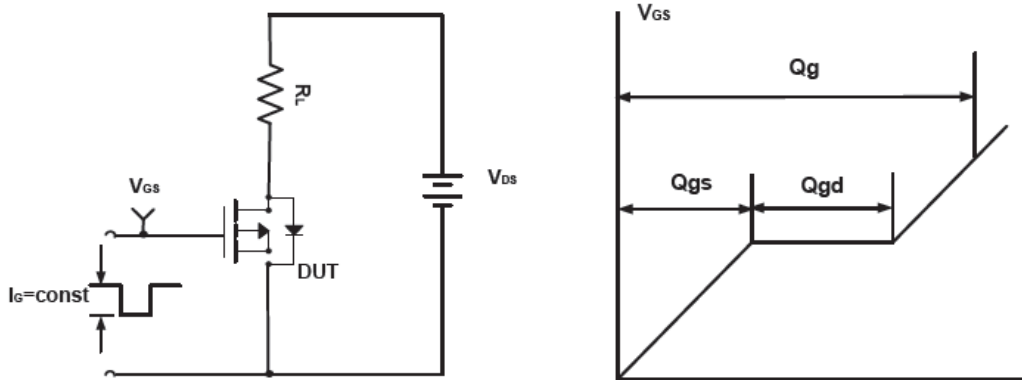
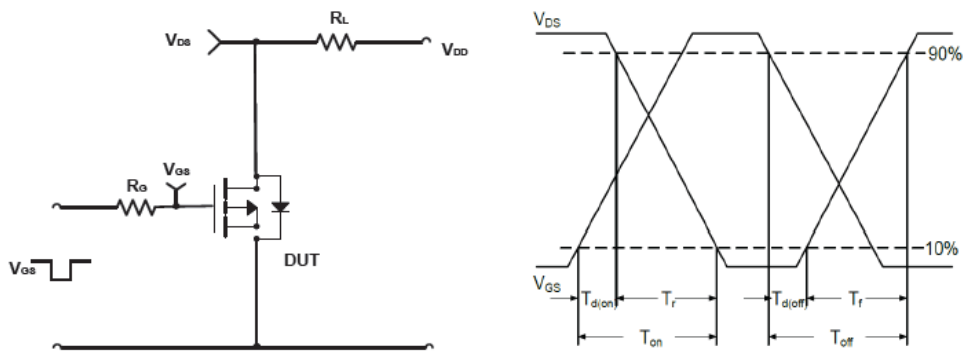

Figure D Gate Charge Test Circuit & Waveforms



FigureE Switching Test Circuit & Waveforms

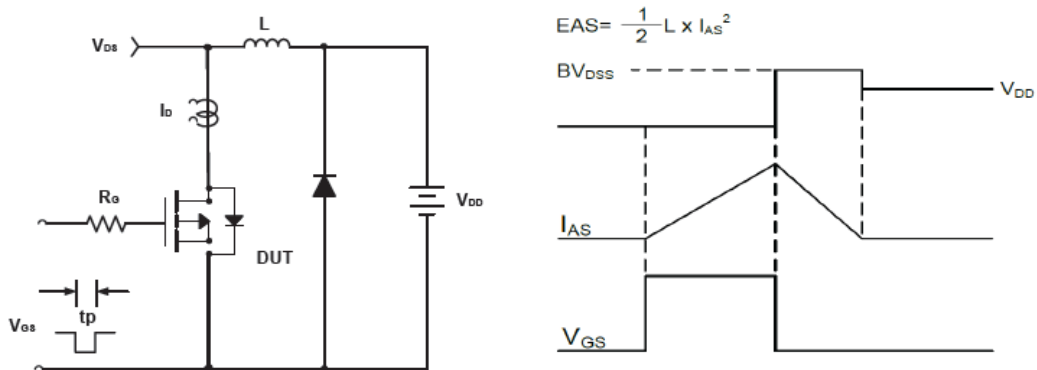
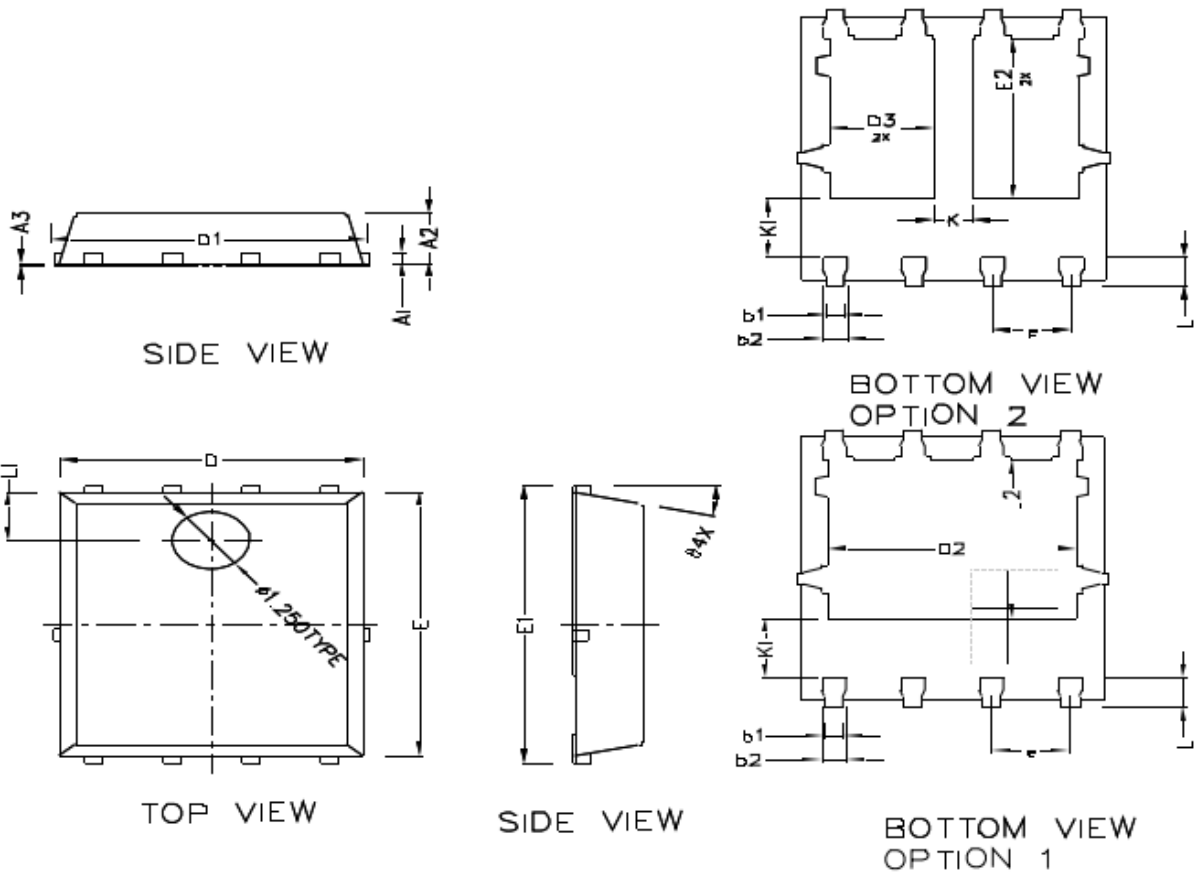

Figure F Unclamped Inductive Switching Circuit & Waveforms

N And P- Channel Enhancement Mode Power MOSSFET

PDFN5X6-8L Package Outline Dimensions (Units: mm)



	COMMON DIMENSIONS		
	MIN	NORMAL	MAX
A1		0.254 BSC	
A2	1.000	1.100	1.200
A3	0.005	—	0.020
b1	0.250	0.300	0.350
b2	0.350	0.400	0.450
D	4.800	4.900	5.000
D1	5.000	5.100	5.200
D2	3.910	4.010	4.110
D3	1.605	1.705	1.805
E	5.650	5.750	5.850
E1	5.950	6.050	6.150
E2	3.375	3.475	3.575
e	1.270 TYPE		
L	0.530	0.630	0.730
L1	1.00REF		
θ	13° TYPE		
K	0.600 REF		
K1	1.235 REF		